

# UPRR CORRIDOR IMPROVEMENT STUDY

---

## Project Alternatives Memorandum





## Table of Contents

1.	INTRODUCTION .....	1
	<i>Relationship of Project Goals and Alignment Options</i> .....	1
	<i>Memorandum Contents</i> .....	1
2.	RAIL PLANNING CONTEXT .....	2
	<i>Capitol Corridor Service</i> .....	2
	<i>Short-Haul Freight Rail Service</i> .....	2
3.	BIKEWAY DEVELOPMENT STANDARDS .....	7
	<i>On-Street Bikeway Development Standards</i> .....	7
	<i>Multi-Use Pathway Development Standards</i> .....	9
	<i>Rail-with-Trail Design Guidelines</i> .....	9
4.	CONCEPTUAL ALIGNMENT OPTIONS .....	13
	<i>Corridor Study Area Segments</i> .....	14
	<i>Alignment Options Summary</i> .....	17
MAP 1:	OAKLAND .....	18
	<i>Segment 1.1: Fruitvale BART Station to 37<sup>th</sup> Avenue</i> .....	18
	<i>Segment 1.2: 37<sup>th</sup> Avenue to 47<sup>th</sup> Avenue</i> .....	18
	<i>Segment 1.3: 47<sup>th</sup> Avenue to Seminary Avenue</i> .....	20
	<i>Segment 1.4: Seminary Avenue to 81<sup>st</sup> Avenue</i> .....	22
	<i>Segment 1.5: 81<sup>st</sup> Avenue to 105<sup>th</sup> Avenue</i> .....	24
MAP 2:	SAN LEANDRO .....	26
	<i>Segment 2.1: 105<sup>th</sup> Avenue to Peralta Avenue</i> .....	26
	<i>Segment 2.2: Peralta Avenue to Marina Boulevard</i> .....	28
	<i>Segment 2.3: Marina Boulevard to Hesperian Boulevard</i> .....	32
MAP 3:	ALAMEDA COUNTY .....	34
	<i>Segment 3.1: Hesperian Boulevard to Elgin Way</i> .....	34
	<i>Segment 3.2: Elgin Way to Hampton Road</i> .....	38
	<i>Segment 3.3: Hampton Road to A Street</i> .....	40
	<i>Segment 3.4: A Street to D Street</i> .....	42
	<i>Segment 3.5: D Street to Sycamore Avenue</i> .....	44
MAP 4:	HAYWARD .....	46
	<i>Segment 4.1: Sycamore Avenue to Sorensen Road</i> .....	46
	<i>Segment 4.2: Sorensen Road to Tennyson Road</i> .....	48
	<i>Segment 4.3: Tennyson Road to Industrial Parkway</i> .....	50
	<i>Segment 4.4: Industrial Parkway to Whipple Road</i> .....	52
MAP 5:	UNION CITY .....	54
	<i>Segment 5.1: Whipple Road to Westgard Street</i> .....	54
	<i>Segment 5.2: Westgard Street to Decoto Road</i> .....	56
	<i>Segment 5.3: Decoto Road to Alvarado Niles Road</i> .....	58
APPENDIX A:	HDR MEMORANDUM .....	61

## List of Tables

TABLE 1: ALIGNMENT OPTIONS.....	17
---------------------------------	----

## List of Figures

FIGURE 1: RAIL PLANNING CONTEXT .....	5
FIGURE 2: CALTRANS BIKEWAY CLASSIFICATIONS .....	8
FIGURE 3: RWT TYPICAL SETBACK.....	10
FIGURE 4: RWT WITH CONSTRAINTS.....	12
FIGURE 5: CONCEPTUAL ALIGNMENT OPTIONS .....	14
FIGURE 6: CORRIDOR MAP .....	15
FIGURE 7: SEGMENTS 1.1 AND 1.2 ALIGNMENT OPTIONS.....	19
FIGURE 8: SEGMENT 1.3 ALIGNMENT OPTIONS .....	21
FIGURE 9: SEGMENT 1.4 ALIGNMENT OPTIONS .....	23
FIGURE 10: SEGMENT 1.5 ALIGNMENT OPTIONS.....	25
FIGURE 11: SEGMENT 2.1 ALIGNMENT OPTIONS.....	27
FIGURE 12: SEGMENT 2.2A ALIGNMENT OPTIONS.....	29
FIGURE 13: SEGMENT 2.2B ALIGNMENT OPTIONS .....	30
FIGURE 14: SEGMENT 2.3 ALIGNMENT OPTIONS.....	33
FIGURE 15: SEGMENT 3.1A ALIGNMENT OPTIONS.....	35
FIGURE 16: SEGMENT 3.1B ALIGNMENT OPTIONS .....	36
FIGURE 17: SEGMENT 3.2 ALIGNMENT OPTIONS.....	39
FIGURE 18: SEGMENT 3.3 ALIGNMENT OPTIONS.....	41
FIGURE 19: SEGMENT 3.4 ALIGNMENT OPTIONS.....	43
FIGURE 20: SEGMENT 3.5 ALIGNMENT OPTIONS.....	45
FIGURE 21: SEGMENT 4.1 ALIGNMENT OPTIONS.....	47
FIGURE 22: SEGMENT 4.2 ALIGNMENT OPTIONS.....	49
FIGURE 23: SEGMENT 4.3 ALIGNMENT OPTIONS.....	51
FIGURE 24: SEGMENT 4.4 ALIGNMENT OPTIONS.....	53
FIGURE 25: SEGMENT 5.1 ALIGNMENT OPTIONS.....	55
FIGURE 26: SEGMENT 5.2 ALIGNMENT OPTIONS.....	57
FIGURE 27: SEGMENT 5.3 ALIGNMENT OPTIONS.....	59

## 1. Introduction

This working paper presents alignment options for a multi-use pathway along the Union Pacific Railroad (UPRR) Oakland Subdivision from the Fruitvale BART Station (Oakland) in the north to the Union City Intermodal Station (Union City) and Fremont-Union City border in the south. Factors influencing feasibility analysis of a multi-use pathway include right-of-way availability, existing and planned freight rail service, existing and planned Bay Area Rapid Transit District (BART) high-speed commuter rail service, and existing and planned Capitol Corridor Joint Powers Authority/AMTRAK (CCJPA) service, as well as other significant physical constraints such as at-grade utilities and roadway crossing configurations. Planned transit-oriented residential and mixed-use development projects have influence over the corridor as well but do not fundamentally impact alignment alternatives located within the UPRR right-of-way and adjacent public streets.

### *Relationship of Project Goals and Alignment Options*

Consistent with the goals identified for this study, the alignments options and analysis presented here respond to the following general criteria:

- Identify a continuous multi-use pathway (Goal 1)
- Balance continuous multi-use pathway alignments with existing, potential and planned rail operations in the corridor (Goal 2)
- Identify opportunities to enhance public access to open space and neighborhood assets (Goal 3)

### *Memorandum Contents*

This memorandum presents the rail planning context influencing the alignment options; guiding design principles and standards governing the physical dimensions of typical design scenarios; and, alignment options by segment from north to south.

- Section 2 presents the rail planning context and includes a summary of active planning for the Oakland Subdivision including: Capitol Corridor service, short-haul freight service, and BART expansion
- Section 3 presents design standards including a discussion of California bikeway and multi-use pathway design standards and rail-with-trail design standards
- Section 4 presents multi-use pathway conceptual alignment options for the Oakland Subdivision responding to the material summarized in Section 2 and Section 3. This report section presents a consistent set of alignment options for each typical segment, demonstrating where in the Oakland Subdivision right-of-way or parallel publicly-owned property a multi-use pathway could be constructed.

## 2. Rail Planning Context

In direct response to Project Goal 2, to identify strategies to preserve the Oakland Subdivision as a multi-modal corridor that balances the needs of a multi-use path with existing and planned rail operations, this working paper presents multi-use pathway alignment options in the context of current rail and land use planning activities. As of the writing of this document, there are two primary future rail planning scenarios that require consideration. These rail scenarios directly influence the engineering feasibility for a multi-use pathway in the UPRR Oakland Subdivision and influence potential sale of the right-of-way. These rail planning scenarios include Capitol Corridor service and Short-Haul Freight Service. Each of these is summarized in greater detail below.

Current assumptions regarding the physical locations of each of these potential rail operations scenarios are presented in **Figure 1**.

### *Capitol Corridor Service*

This scenario assumes operation of Capitol Corridor/Amtrak service in the Oakland Subdivision from Industrial Parkway (Hayward) in the north to the Union City Intermodal Station (Union City) in the south. CCJPA would acquire the UPRR Oakland Subdivision from Industrial Parkway in the north to Union City Intermodal Station in the south. This scenario is assumed to have a high degree of likelihood for purposes of this study based on completion of preliminary engineering and environmental clearance, Metropolitan Transportation Commission (MTC) authorization of CCJPA to lead property acquisition negotiations with the UPRR, and available funding for exploration of purchase.

Capitol Corridor service from Industrial Parkway in the north to Union City Intermodal Station in the south would influence multi-use trail feasibility on the Oakland Subdivision in the following ways:

- South of Industrial Parkway in Hayward, Capitol Corridor service will transition from the Niles Subdivision to the Oakland Subdivision
- Existing UPRR freight tracks would be maintained and provide shared passenger and freight service
- Passing and storage tracks would be maintained and expanded along some segments, requiring a two track configuration
- Should the Oakland Subdivision right-of-way be acquired using public funds it will be for rail improvements, making development of a multi-use pathway south of Industrial Parkway unlikely.

### *Short-Haul Freight Rail Service*

This scenario assumes that a short-haul rail operator would provide freight service between the Port of Oakland and a planned shipping distribution and logistics center located on the former Crow's Landing Naval Air Station in Stanislaus County, California. Operation of the short-haul freight service on the Oakland Subdivision has two potential scenarios. Current negotiation is focused on use of the Oakland Subdivision from the Central Valley to Industrial Parkway. North of Industrial Parkway short-haul freight service would likely be operated on the Niles Subdivision, with offset hours of operation, along with the Capital Corridor passenger service. This consolidation of freight

and passenger service on the Niles Subdivision between Industrial Parkway and 98<sup>th</sup> Avenue in the north would justify greater investment in rail improvements on the Niles Subdivision and free the Oakland Subdivision for other uses. North of 98<sup>th</sup> Avenue to 47<sup>th</sup> Avenue freight service may continue on the Oakland Subdivision, serving current freight customers in this area. The Crow's Landing and short-haul rail project developer is seeking various agency partnerships and funding sources to initiate detailed planning, engineering and environmental clearance to establish this rail service.

Short-haul freight service from Industrial Parkway in the north to Union City Intermodal Station in the Union City/Fremont boundary in the south would influence multi-use trail pathway feasibility in the following ways:

- Existing UPRR freight tracks on the Oakland Subdivision would be used by a short-haul freight operator during offset peak periods so as to limit conflict with passenger rail use
- Passing and storage tracks would be maintained and expanded along some segments, requiring a two track configuration
- If the Oakland Subdivision is publicly acquired for passenger rail improvements it is possible that freight service would continue south of Industrial Parkway.

*This page intentionally left blank*



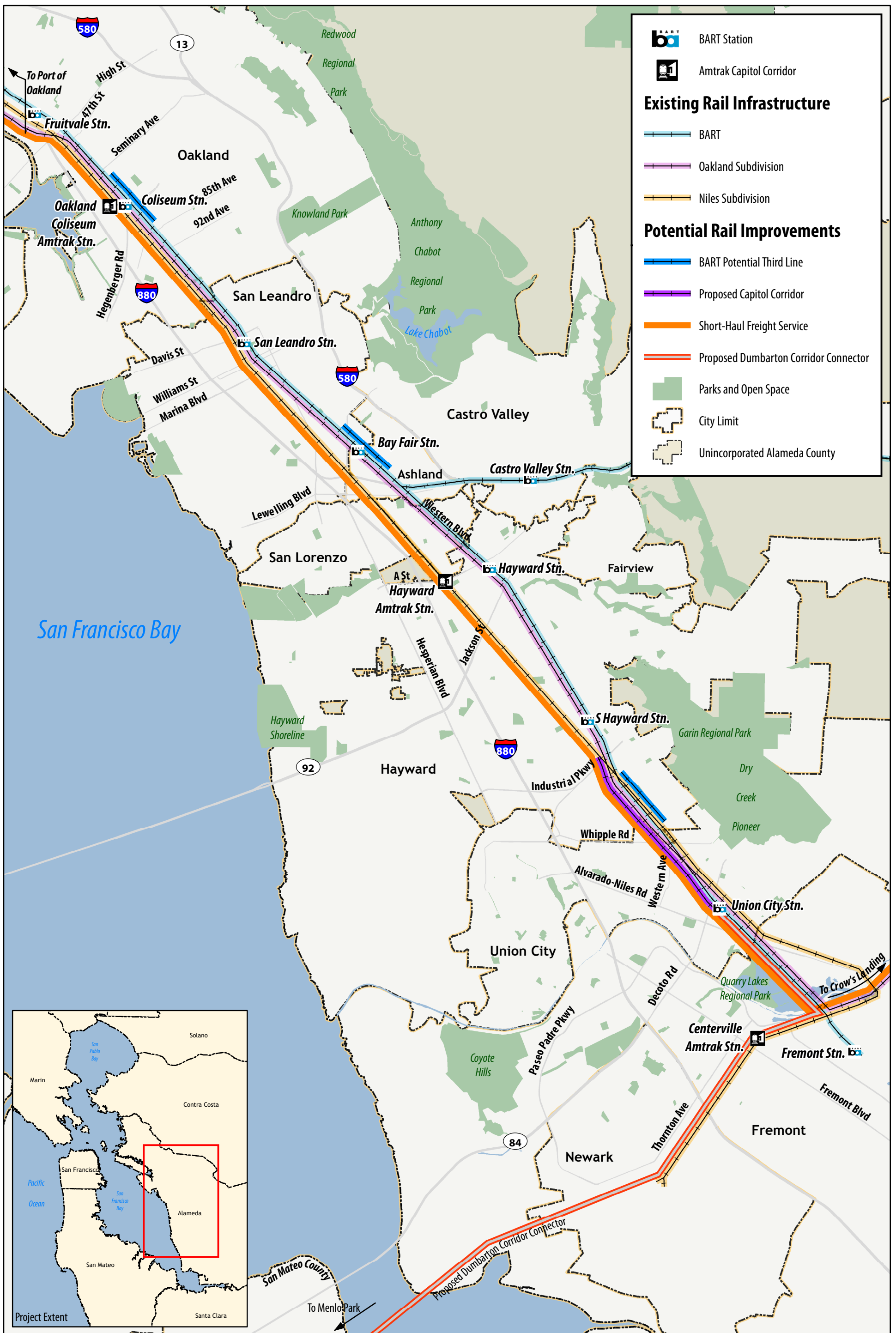

**Figure 1: Rail Planning Context**

**UPRR Corridor Improvement Study**

Source: Data obtained from MTC and ESRI  
 Author: Tony Salomone  
 Date: 6/15/09



### 3. Bikeway Development Standards

This section presents bikeway design standards and guidelines for on-street bikeways, multi-use pathways and rail-with-trail facilities. Each of these facility types appears in the alignment options presented below in Section 4 of this memorandum. The three distinct categories of design guidance are featured in this document as follows:

- On-street bikeway design standards provide important context and guidelines for corridor segments where alignment options take advantage of public streets and sidewalks
- Multi-use pathway design standards are important on segments where it may be feasible to remove existing rails from the Oakland Subdivision or where sufficient public right-of-way may exist to create a multi-use pathway immediately parallel to the Oakland Subdivision
- Where rail is likely to remain in place, and where a multi-use pathway may be feasible in conjunction with operating rail, alignment options adhere to generally accepted rail-with-trail design guidelines.

Each of these bikeway development standards is presented in greater detail below, summarizing key dimensions and operating characteristics.

#### *On-Street Bikeway Development Standards*

On-street alignment options are required for some segments where no feasible alignment option can be achieved in the UPRR Oakland Subdivision railroad right-of-way. Multi-lane streets along the project corridor such as San Leandro Street (Oakland), San Leandro Boulevard (San Leandro) and narrow neighborhood streets such as Western Boulevard (San Leandro) serve a variety of regional, local and truck traffic depending on the segment under consideration. In all cases, the site specific traffic operations and safety must be analyzed prior to formal recommendation of any on-street bikeway. Section 4 indicates the appropriate level of study to determine on-street bikeway feasibility for each segment where this option is presented. In addition, Section 4 of this document also identifies where on-street bikeways have been studied and/or recommended as a part of the local bikeway plan.

Caltrans has defined three types of bikeways in Chapter 1000 of the Highway Design Manual: Class I, Class II, and Class III. Minimum standards for each of these bikeway classifications are shown below in **Figure 2**.

**CLASS I  
Multi-Use Path**

Provides a completely separated right of way for the exclusive use of bicycles and pedestrians with crossflow minimized.

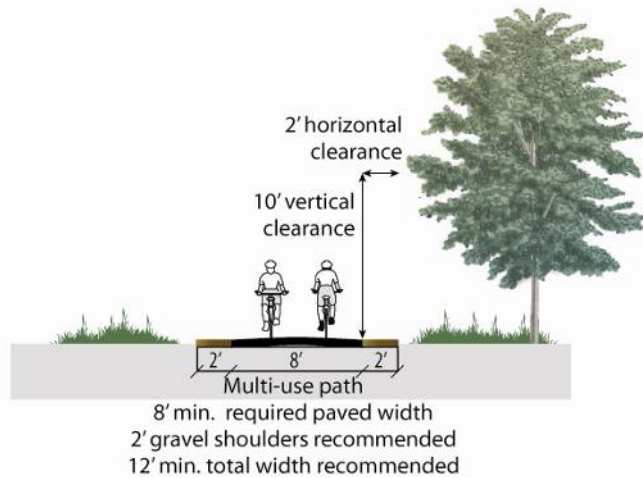
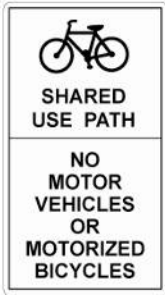

**CLASS II  
Bike Lane**

Provides a striped lane for one-way bike travel on a street or highway.

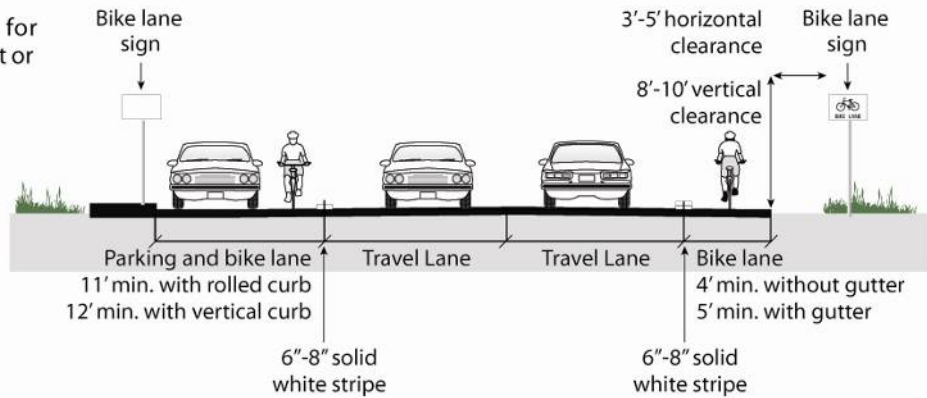

**CLASS III  
Bike Route  
Signed Shared Roadway**

Provides for shared use with pedestrian or motor vehicle traffic, typically on lower volume roadways.

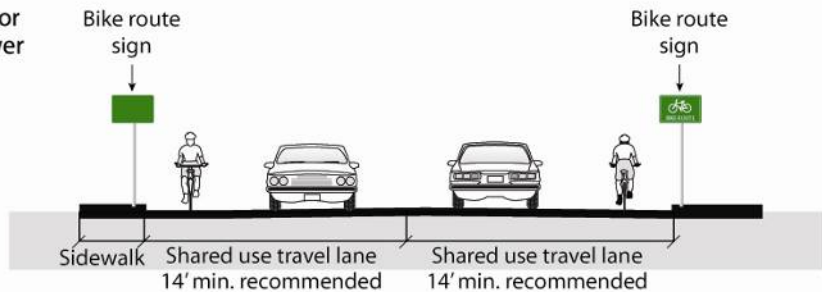

Figure 2: Caltrans Bikeway Classifications

## *Multi-Use Pathway Development Standards*

Multi-use pathway design standards are important on segments where it may be feasible to remove existing rails from the Oakland Subdivision, where sufficient public right-of-way may exist to create a multi-use pathway immediately parallel to the Oakland Subdivision. Many segments where the Oakland Subdivision immediately abuts public street right-of-way afford the opportunity to redefine the boundary and create a Class I multi-use pathway in an expanded sidewalk frontage zone, subject to minimum design standards addressed below.

Caltrans Class I standards for a multi-use pathway, as presented in **Figure 2**, specify a minimum paved width of eight feet with two-foot wide clear shoulders on each side. Generally, in a potential high use multi-use trail environment with a variety of trail user groups, greater width is preferred. For example, the San Francisco Bay Trail segments in the East Bay are typically 10 to 14 feet in paved width.

Setback from existing roadway travel lanes is an important consideration for this project on segments where Class I facilities are recommended immediately parallel to urban arterial streets. Caltrans specifies that the edge of the paved surface of a Class I facility shall be five feet minimum from the edge of an adjacent paved highway. In an urban street context, a variety of features may mitigate this requirement including a combination of clear buffer, on-street parking, use of vertical fixed barriers and landscaped buffers.

In general, multi-use pathways should not be located immediately adjacent to roadways where there are frequent driveway crossings, frequent intersecting roadways, or other potential conflicts limit usability of the pathway by bicyclists.

## *Rail-with-Trail Design Guidelines*

Where rail is likely to remain in place, and where a multi-use pathway may be feasible in conjunction with operating rail, alignment options adhere to generally accepted rail-with-trail design guidelines. This section briefly summarizes design guidelines and engineering best practices for rail-with-trail (RWT) facilities. There are four primary design characteristics that are most relevant at this high-level planning analysis to determine potential linear multi-use pathway alignment options for the UPRR Oakland Subdivision, including:

- Setback distance of the trail from the centerline of the active railroad track
- Separation requirements between the pedestrian and bicycle facility and the active railroad, such as fencing, landscape, or berm
- At-grade railroad crossings where the multi-use pathway must cross the railroad tracks
- Roadway crossing standards where the multi-use pathway must cross a roadway serving car and truck traffic, including both at-grade and grade separated considerations.

Each of these design characteristics and associated standards and best practices area summarized in greater detail below.

It is important to acknowledge that RWT design practice is highly contextual and that no uniform adopted standards exist. Site specific design, safety, and operations analysis is required to develop appropriate design for each RWT taking into account rail frequency, rail operating speed, crossing

frequency and type, as well as multi-use pathway demand and anticipated user groups. Another important consideration for this project is that privately owned railroad owning/operating entities have generally elected to adhere to more conservative setback and separation requirements than publicly railroad owner/operators. Where relevant to a specific segment and associated alignment options, this last point is referenced with additional explanation in Section 4.

### Setback Standards

The following standards are excerpted from *Rails-with-Trails: Lessons Learned Literature Review, Current Practices, Conclusions*<sup>1</sup> authored by Alta Planning + Design for the Federal Highway Administration and represent the current engineering best practice for RWT setback. Because of the lack of consensus on acceptable setback distances, the appropriate distance must be determined on a case-by-case basis<sup>2</sup>. Trail planners should incorporate into the feasibility study analysis an analysis of technical factors, including:

- Type, speed, and frequency of trains in the corridor
- Separation technique
- Topography
- Sight distance
- Maintenance requirements, and
- Historical problems.

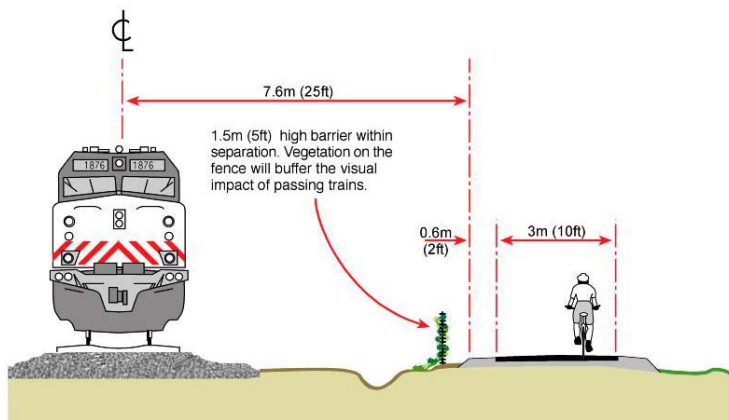

*Figure 3: RWT Typical Setback*



*Existing RWT with Narrow Setback*

Another determining factor may be corridor ownership. Trails proposed for privately-owned property will have to comply with the railroad's own standards. Trail planners need to be aware that the risk of injury should a train derail will be high, even for slow-moving trains. Discussions about liability assignment need to factor this into consideration.

In many cases, adequate setback widths, typically 7.6 m (25 ft) or higher (**Figure 3**), can be achieved along the majority of a corridor. However, certain constrained areas will not allow for the desired setback width. Safety should not be compromised at these pinch points – additional barrier devices should be used, and/or additional right-of-way purchased. In the case of high speed freight or transit lines, RWTs must be located as far from the tracks as possible and are infeasible if adequate

<sup>1</sup> *Rails-with-Trails: Lessons Learned Literature Review, Current Practices, Conclusions*, Federal Highway Administration. 2002.

<sup>2</sup> *Ibid.*

setbacks and separation cannot be achieved. At an absolute minimum, trail users must be kept outside the “dynamic envelope” of the track – that is, the space needed for the train to operate.

According to the MUTCD (Section 8), the dynamic envelope is “the clearance required for the train and its cargo overhang due to any combination of loading, lateral motion, or suspension failure.” It includes the area swept by a turning train. Relatively narrow setback distances of 3 m (10 ft) to 7.6 m (25 ft) may be acceptable to the railroad, RWT agency, and design team in certain situations, such as in constrained areas, along relatively low speed and frequency lines, and in areas with a history of trespassing where a trail might help alleviate a current problem. The presence of vertical separation or techniques such as fencing or walls also may allow for narrower setback.

### **Separation Standards**

Most railroad companies require a RWT to provide separation between the rail and trail, usually fencing. Typically, railroad companies require 6-foot fences regardless of setback. Where the setback is greater than 25-feet or at constrained points, other separation types are sometimes used. Vegetation, ditches or berms are common alternative barriers.

Fences and walls are the most common type of physical barrier used in RWT corridors. Most railroads will require or request fencing, for which the trail management agency will be responsible. The height and type of material used on these barriers determines their effectiveness in discouraging trespassing and the resulting impact on required setback distance. A tall wall or fence constructed with materials that are difficult to climb should deter all but the most determined trespasser. From the trail manager’s perspective, fencing is a mixed blessing. Installing and maintaining fencing is expensive. Improperly maintained fencing is a higher liability risk than no fencing at all. In all but the most heavily-constructed fencing, vandals may find ways to cut, climb, or otherwise overcome fences to reach their destinations. Fencing also detracts from the aesthetic quality of a trail.

The visual quality of fencing materials can have an impact on illegal activities along RWTs. For example, the Canadian Pacific Railway (CPR) Police Service has had dramatic results in reducing crime and trespassing through RWT designs that improved the aesthetic quality of an area. Their approach relies on the concept of “Crime Prevention through Environmental Design (CPTED),” meaning, the proper design and effective use of the built environment can lead to a reduction in the incidence and fear of crime.

Particularly for an urban trail in an area with crime problems, it may be important to maintain visual access to the trail corridor from adjacent land uses, so that portions of the trail do not become isolated from public view. Fence design in these instances should not block visual access to the trail corridor. Tall fences that block views can cause sight distance problems at intersections with roadways—both for motorists who must be able to view approaching trains, and for trail users who need adequate sight lines to view traffic conditions.



*Existing RWT with Narrow Setback and Fence Separation*

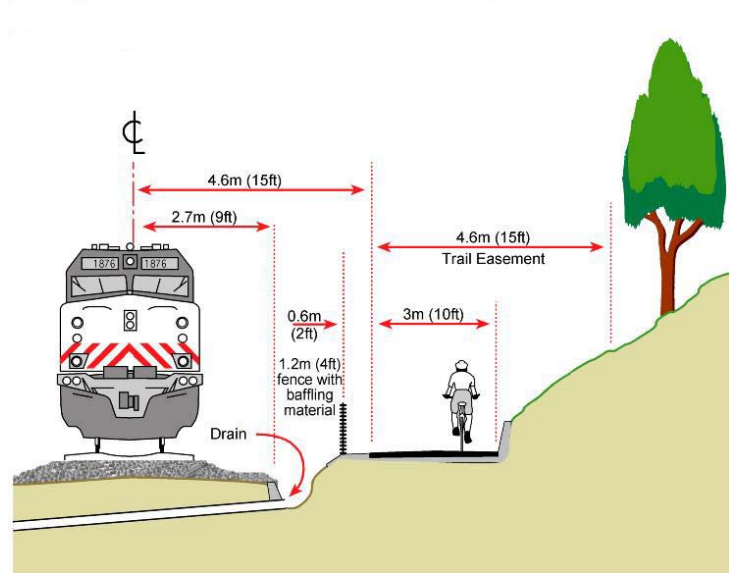

*Figure 4: RWT with Constraints*

### Railroad Crossing Standards

The point at which trails cross active tracks is the area of greatest concern to railroads, trail planners, and trail users. Railroad owners, the FHWA, and State DOTs have spent years working to reduce the number of at-grade crossings in order to improve public safety and increase the efficiency of service. RWT design should minimize new at-grade crossings wherever possible.

The California Public Utilities Commission (CPUC) and UPRR have adopted policies of no new at-grade crossings. Using existing crossings or building grade-separated crossings are the only alternative to crossing active rail lines where a multi-use pathway must do so.

### Multi-Use Pathway Roadway Crossing Standards

RWTs may cross at-grade roadways or grade-separated roadways. Whenever possible, trail users should be routed to an existing signalized crossing at at-grade roadway crossings. Grade-separated crossings should be designed and constructed to accommodate heavy railroad trucks and equipment.

### At-Grade Roadway Crossings

At-grade crossings between RWTs and roadways can be complex areas that require the designer to think from the perspective of all types of users who pass through the intersection: trains, motorists, bicyclists, and pedestrians. Trail-roadway intersections are covered in detail by both the AASHTO Bike Guide and the MUTCD. While these manuals do not specifically recommend solutions for RWT crossings, they cover basic safety principles that apply to all trail-roadway crossings. Variables to consider when designing trail-roadway intersections include right-of-way assignment, traffic control devices, sight distances, access control, pavement markings, turning movements, traffic volume, speed, and number of lanes. Refer to the AASHTO Bike Guide for information regarding these design factors. All traffic control devices should comply with the MUTCD.



This study will present typical design and generalized design considerations for intersections in the draft plan.

### **Grade-Separated Crossings**

Use of the existing railroad trestle and bridge structures over arterial roadway along the Oakland Subdivision will be feasible only where rail service is removed. Discussion of these existing structures and their feasibility for multi-use pathway use will be addressed in greater detail in the draft plan.

Where rail use is likely to continue the existing rail trestle and bridges will not accommodate pedestrian and bicycle traffic and new structures will be required. These options may be very expensive and may have negative environmental impacts if it requires construction in a riparian or other habitat. Where new pedestrian and bicycle bridges are required over the State highways and major arterial roadways along the corridor, the engineering and approvals process is likely to be complex and costly.

## **4. Conceptual Alignment Options**

Considering the rail planning context, multi-use pathway development standards, and physical configuration of the existing UPRR Oakland Subdivision right-of-way, several generalized alignment options clearly emerge throughout the corridor. Five consistent alignment options are evaluated for each segment of the study corridor including:

**Option A. BART Right-of-Way East:** is located east of the elevated BART tracks or at-grade tracks, dependent on available area and minimum setbacks. Option A is located entirely or partially on the area of BART ownership or BART joint-use agreement with UPRR.

**Option B. BART Right-of-Way West:** is located west of the elevated BART tracks or at-grade tracks, dependent on available area and minimum setbacks. Option B is located entirely or partially on the area of BART ownership or joint-use agreement with UPRR.

**Option C. UPRR Right-of-Way:** is located in the area of UPRR ownership and, depending on location, can be achieved with a limited setback from the existing rail or would require removal of rail in order to be feasible. Option C is located entirely in areas of UPRR ownership.

**Option D. Public Street Right-of-Way:** is located with publicly-owned street rights-of-way located immediately parallel to the UPRR Oakland Subdivision, in most cases immediately abutting the railroad right-of-way. Option D includes multi-use pathways immediately parallel to the street as well as on-street bikeway options.

**Option E. Separate Parallel Alignment:** where Options A through D do not appear feasible due to BART and UPRR right-of-way constraints and where an immediately parallel public right-of-way does not exist a fifth option of a separate but parallel corridor was considered.

**Figure 5** presents these conceptual alignment options in a single cross section to illustrate the general location of each. All cross-sections presented in Section 4 of this memorandum are facing north, consistent with **Figure 5**.

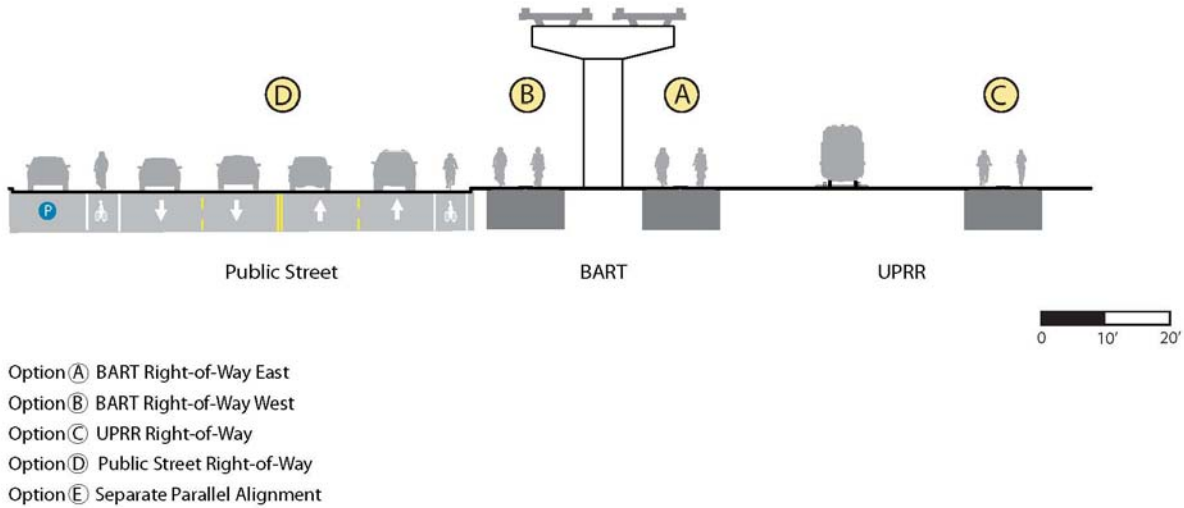

*Figure 5: Conceptual Alignment Options*

### *Corridor Study Area Segments*

The maps and segments used in this memorandum are consistent with those presented in Working Paper 2: Opportunities and Constraints. The five map subareas shown in **Figure 6** correspond to the city and County boundaries including:

- Oakland
- San Leandro
- Unincorporated Alameda County
- Hayward, and
- Union City.

Each map subarea is further divided into typical segments based on right-of-way width, passenger rail characteristics, freight rail characteristics, adjacent land use, and access. Each of the typical cross sections presented below correspond to these typical segments. Even within these segments there is significant variation among key variables such as number of existing rail tracks, right-of-way width, presence of above ground utilities and rail equipment, configuration of the BART elevated structure and other factors. Nonetheless these segments do represent relative consistency and are appropriate corridor divisions at this level of planning analysis.

The following section presents the corridor segments in cross-sectional view illustrating the following elements:

- Right-of-way width (prevailing typical width for the segment)
- Approximate location of property ownership and joint-use areas
- Existing location of freight tracks and passenger rail tracks
- Physical location in of the potential alignment options (A through E).

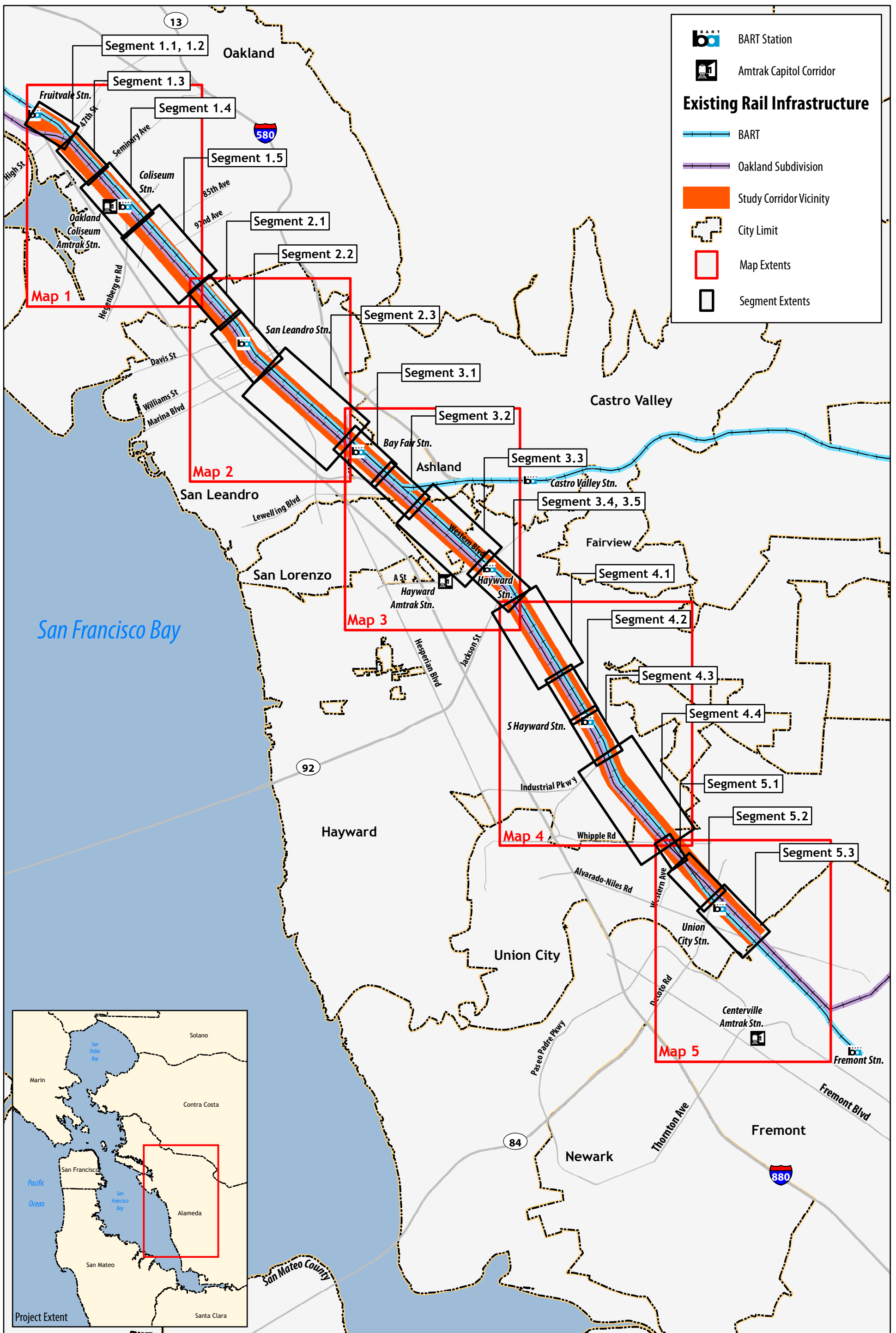

**Figure 6: Project Corridor Segments**

**UPRR Corridor Improvement Study**

Source: Data obtained from MTC and ESRI  
 Author: Tony Salomone  
 Date: 6/15/09



### Alignment Options Summary

**Table 1** presents a summary analysis of the alignment options discussed in greater detail below. This table is intended to provide an overview only. “Y,” or Yes, indicates a preliminary assessment that the alignment option is feasible as presented below. “N,” or No, indicates a preliminary assessment that the specific alignment option is not feasible for a given segment. In some cases the alignment option will require the removal of one or more of the at-grade UPRR rail tracks. Where such removal would be required the “Y” is asterisked.

*Table 1: Alignment Options*

Segment	Option A BART ROW East	Option B BART ROW West	Option C UPRR ROW	Option D Public Street Right-of-Way	Option E Separate Parallel Alignment
1.1	N	Y	N	Y	N/A
1.2	N	N	N	Y	N/A
1.3	Y	Y	Y	Y	N/A
1.4	Y	Y	Y*	Y	N/A
1.5	Y	Y	Y*	Y	N/A
2.1	Y	Y	Y	Y	N/A
2.2	N	Y	Y	Y	N/A
2.3	Y	Y	Y	Y	N/A
3.1A	N	Y	Y	N	N/A
3.1B	Y	Y	Y	N	N/A
3.2	N	N	Y	N	N/A
3.3	N	N	Y	Y	N/A
3.4	N	N	Y*	N	N/A
3.5	N	N	Y	N	N/A
4.1	N	N	Y	Y	N/A
4.2	N	N	Y*	N	Y
4.3	N	N	Y	N	N/A
4.4	N	N	N	N	Y
5.1	N	N	Y	N	N/A
5.2	Y	N	Y	Y	N/A
5.3	N	N	N	Y	N/A

\* Indicates some UPRR track removal required (may not be all tracks).

## Map 1: Oakland

Map 1 begins in the City of Oakland at the Fruitvale BART Station and continues to 105<sup>th</sup> Street near the San Leandro Border.

### *Segment 1.1: Fruitvale BART Station to 37<sup>th</sup> Avenue*

Segment 1.1 is immediately adjacent to the Fruitvale BART Station and is surrounded by the Fruitvale Transit Village, a mixed-use transit-oriented development. The BART tracks are elevated and there are no at-grade UPRR tracks. The BART right-of-way (ROW) is occupied by the BART station and parking lot. There are no known potential rail scenarios that would influence alignment options in this segment.

Alignment options in Segment 1.1 are limited (**Figure 7**). Alignment Option A, a multi-use path within the BART ROW East is restricted by the BART Station and existing parking, as well as the potential third BART track. Option C, a path within the UPRR ROW, is not feasible because there is no UPRR ROW in this segment.

Potential alignment options include a multi-use path on the BART ROW West (Option B) and a bike lane on San Leandro Street. A bike lane on San Leandro Street (Option D) would likely require the removal of two traffic lanes.

### *Segment 1.2: 37<sup>th</sup> Avenue to 47<sup>th</sup> Avenue*

Segment 1.2 is defined by its industrial uses, mid-block corridor location and occupied ROW. BART tracks are elevated and there are no at-grade UPRR tracks. The at-grade rail tracks have been removed and in many cases the ROW is occupied by industrial storage. The ROW is approximately 42 feet. There are no known potential rail scenarios that would influence alignment options in this segment.

The alignment options in Segment 1.2 are limited due to the occupied ROW. **Figure 7** shows the existing and proposed alignments. Options A, B, and C are not feasible because of occupied ROW. The only feasible alignment is a bicycle lane on San Leandro Street (Option D) which would likely require the removal of two traffic lanes. The City of Oakland's Transportation Services Division of the Community Economic Development Agency would need to conduct a feasibility study in order to remove traffic lanes. The feasibility study would include review of available right-of-way and impacts to vehicular level of service.

The East Bay Greenway's preferred route for both Segments 1.1 and 1.2 is a Class II bike lane on San Leandro Street. The Oakland Bicycle Plan identifies the East Bay Greenway as a priority project and also identifies a Class III bike route on East 12<sup>th</sup> Street.



Segment 1.1 and 1.2 Typical Site Conditions  
(Image facing north)

**Segment 1.1 Alignment Options  
Fruitvale BART Station to 37th Avenue**

- Ⓐ BART ROW East- Infeasible
- Ⓑ BART ROW West
- Ⓒ UPRR ROW- Not Present in this Segment
- Ⓓ Public Street ROW- See Segment 1.2

**ALIGNMENT OPTIONS**

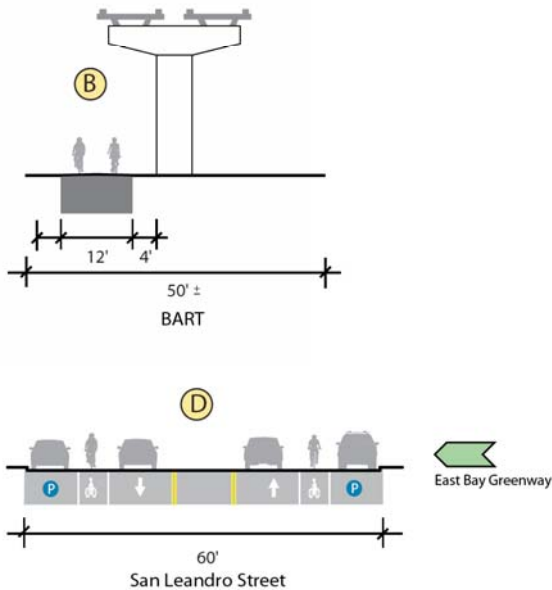

**Segment 1.2 Alignment Options  
37th Avenue to 47th Avenue**

- Ⓐ BART ROW East- Infeasible
- Ⓑ BART ROW West- Infeasible
- Ⓒ UPRR ROW- Not present in this segment
- Ⓓ Public Street ROW- San Leandro Street Bicycle Lane

**EXISTING**

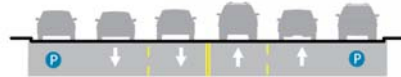

**ALIGNMENT OPTION**

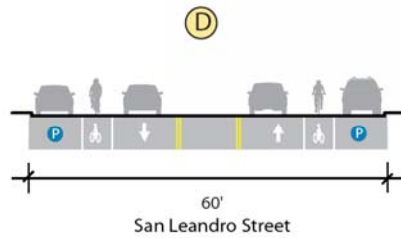

- Notes:
1. Property ownership/ROW varies significantly through the corridor and the sketch is a representation of typical dimensions.
  2. All dimensions presented are accurate for conceptual design and planning purposes only.
  3. All sections facing north.



Figure 7: Segments 1.1 and 1.2 Alignment Options

### *Segment 1.3: 47<sup>th</sup> Avenue to Seminary Avenue*

Segment 1.3 is bound primarily by industrial uses. The UPRR ROW contains two at-grade tracks and parallels the elevated BART tracks. The ROW is approximately 72 feet wide. UPRR freight service or other short-haul freight is likely to operate on this segment to serve existing freight customers in East Oakland between 47<sup>th</sup> Avenue and 98<sup>th</sup> Avenue.

Alignment options are more varied in this segment than those previously discussed and are illustrated in **Figure 8**.

Option A, a 12-foot path within the BART ROW East, would conform to standard multi-use path design guidelines. The path would be only 24-feet from the rail centerline rather than the typical 25-foot; however this setback distance may be acceptable.

Options B, C and D are feasible. Option B, a path within the BART ROW West, is possible if the roadway is reconfigured to four travel lanes and no curbside parking. This alignment accommodates a 12-foot path and is within standard design guidelines. A 12-foot path within the UPRR ROW, Option C, is feasible within the existing configuration with an approximate 40-foot setback from existing rail freight rail.

Option D, a standard five-foot bike lane on San Leandro Street, is possible if the roadway is reconfigured to two travel lanes with curbside parking. The City of Oakland's Transportation Services Division of the Community Economic Development Agency would need to conduct a feasibility study in order to remove traffic lanes. The feasibility study would include review of available right-of-way and impacts to vehicular level of service.

The East Bay Greenway's preferred route is a multi-use path on a shoulder extended on the western BART ROW and is identified as a priority project in the Oakland Bicycle Plan. The Oakland Bicycle Plan also includes a Class II bike lane on San Leandro Street from 54<sup>th</sup> Avenue to Seminary Avenue.



*Segment 1.3 Typical Site Conditions  
(Image facing south)*



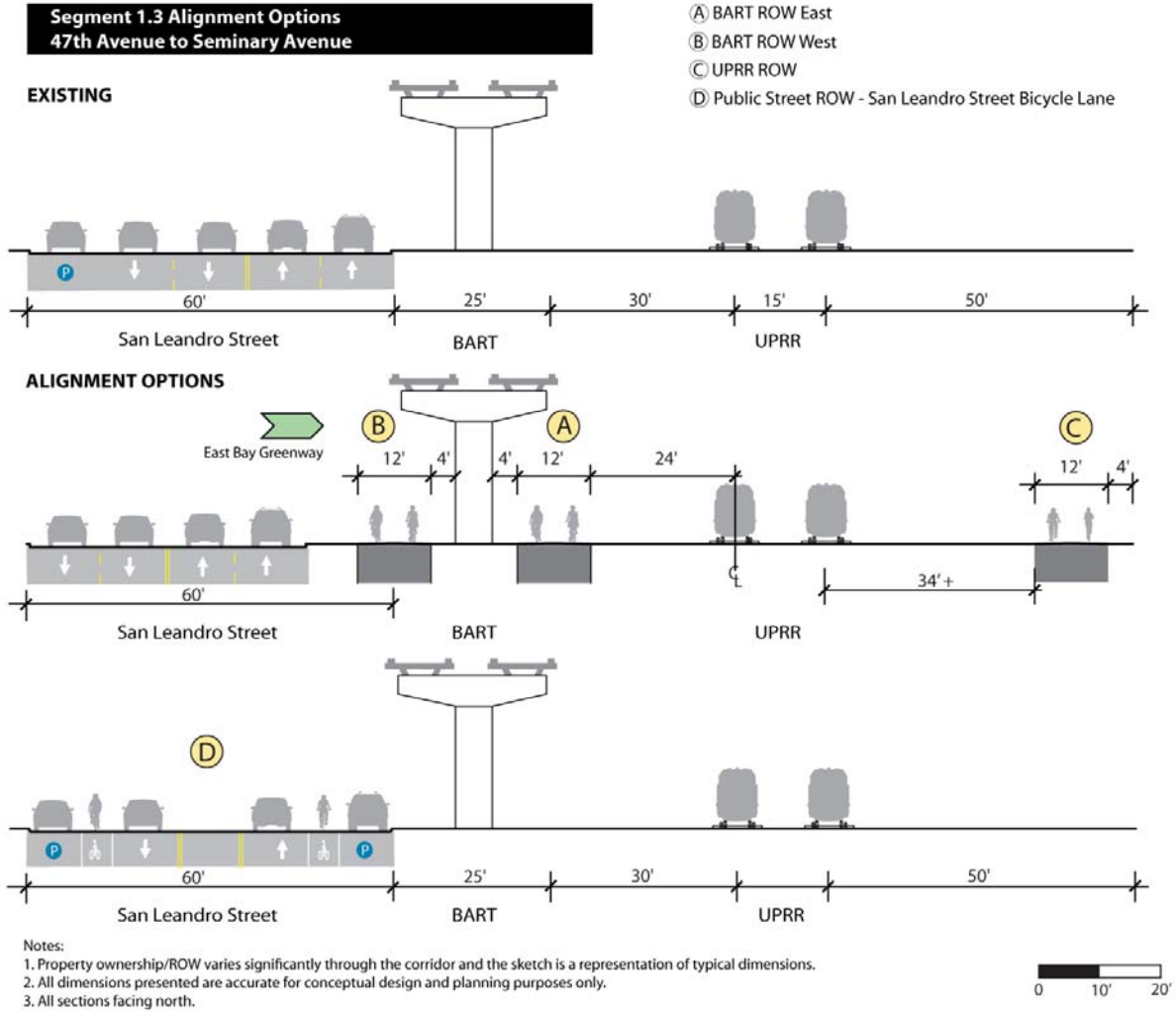

Figure 8: Segment 1.3 Alignment Options

### *Segment 1.4: Seminary Avenue to 81<sup>st</sup> Avenue*

Segment 1.4 includes the Coliseum BART Station and is adjacent to elevated BART tracks. The ROW outside (east) of the BART joint use easement is approximately 60 feet and is currently occupied by two active freight tracks. Known potential rail scenarios include short-haul freight and a potential third BART track that would provide storage and passing capacity at the Oakland Coliseum. Length of the potential third track segment is not known at this time.

**Figure 9** shows Segment 1.4 alignment options. Option A, a facility within the BART ROW East, would be possible with a 20-foot setback from existing rail. This setback is less than typical and may be acceptable with a separation fence.

Option B, a 12-foot multi-use path on the BART ROW West, is feasible if travel lanes are reconfigured to allow an extension of the curb to accommodate a 12-foot multi-use path and buffers.

Option C, a 12-foot path within the UPRR ROW is possible with the removal of the eastern UPRR track which would provide for an approximately 20-foot setback from the remaining operative rail. This option may require a separation fence dependent on negotiations with UPRR and any future short-haul rail operator.

A standard 5-foot bike lane on San Leandro Street (Option D) is also feasible if the roadway is reconfigured to two travel lanes with curbside parking. The City of Oakland's Transportation Services Division of the Community Economic Development Agency would need to conduct a feasibility study in order to reconfigure the travel lanes. The feasibility study would include review of available right-of-way and impacts to vehicular level of service.

The East Bay Greenway's preferred route is a multi-use path on a shoulder extended on the western BART ROW and is identified as a priority project in the Oakland Bicycle Plan. At the Coliseum BART Station, the preferred East Bay Greenway is routed on-street to a proposed Class III bike route east of the Station on Snell Street and back onto a multiuse path in the BART ROW West. The Oakland Bicycle Plan also includes a Class II bike lane on San Leandro Street.



*Segment 1.4 Typical Site Conditions  
(Image facing north)*

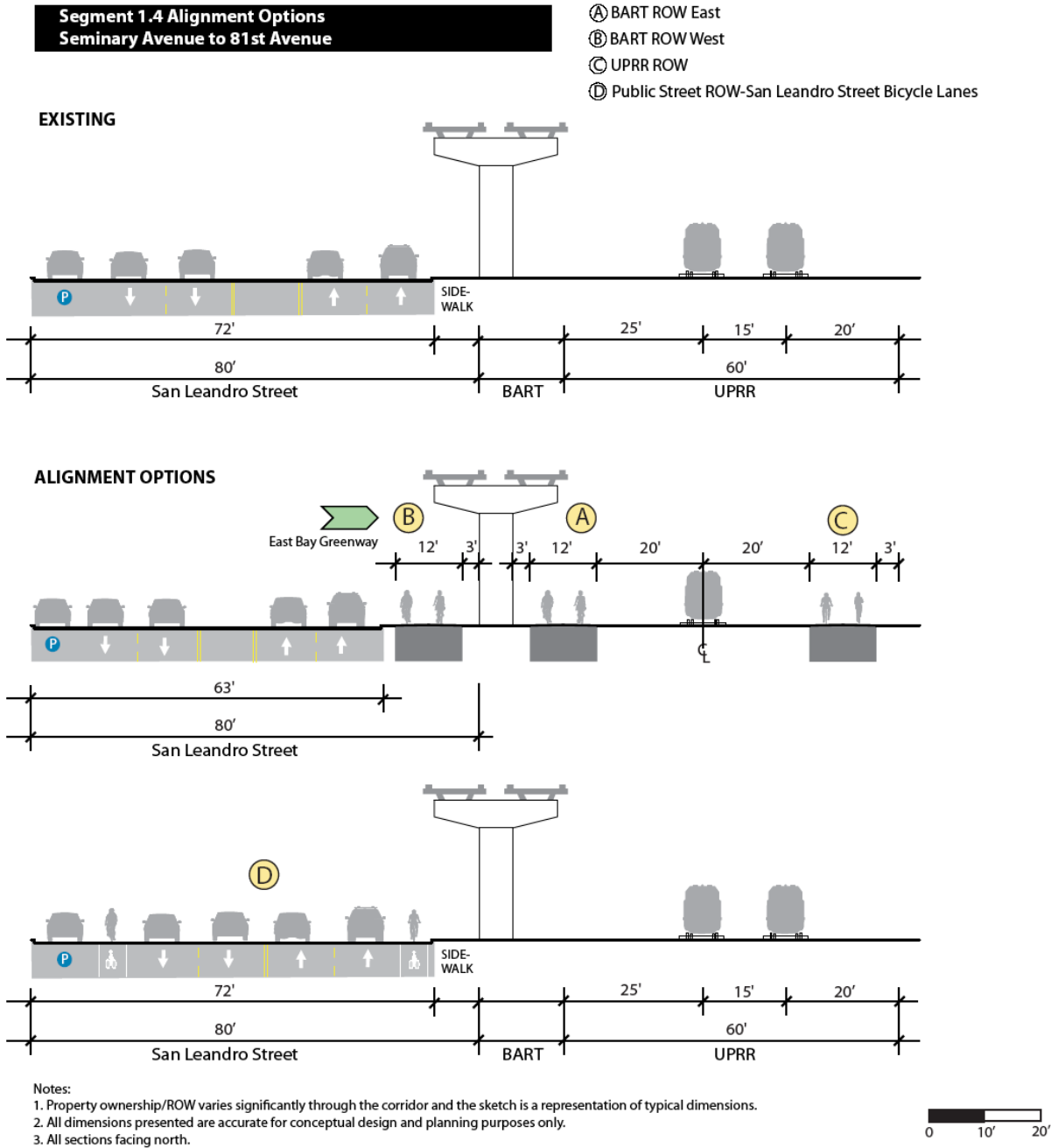

Figure 9: Segment 1.4 Alignment Options

### *Segment 1.5: 81<sup>st</sup> Avenue to 105<sup>th</sup> Avenue*

Segment 1.5 parallels San Leandro Street and includes elevated BART tracks and two at-grade UPRR tracks. There is approximately 60 feet of UPRR right-of-way outside (east) of the joint use area. Within these approximately 60 feet are two existing freight tracks with a roughly 20 foot setback from adjacent property boundaries on each side. UPRR or other short-haul freight service is the only known potential rail scenario in this segment, providing continued service to existing customers.

**Figure 10** shows the Segment 1.5 path alignments. Option A, a 12-foot multi-use path within the BART ROW East would be possible with a 20-foot setback from existing rail. This setback is less than typical and may be acceptable with a separation fence.

Option B, a 12-foot multi-use path within the BART ROW West is feasible if travel lanes widths are reduced to allow roadway narrowing where the path would be placed.

Option C, a path within the UPRR ROW, is possible on the eastern edge of the ROW if the second eastern UPRR track is removed. This would create a 20-foot setback from existing rail and may require a separation fence dependent on negotiations with the UPRR and any future short-haul rail operator.

Option D, a standard 5-foot bicycle lane on San Leandro Street, is possible if the roadway is reconfigured to two travels lanes with curbside parking. The City of Oakland's Transportation Services Division would need to conduct a feasibility study to remove traffic lanes. The feasibility study would include review of available right-of-way and impacts to vehicular level of service.

The East Bay Greenway's preferred route is a multi-use path on the western BART ROW and is identified as a priority project in the Oakland Bicycle Plan. The Oakland Bicycle Plan also includes a Class II bike lane on San Leandro Street.



*Segment 1.5 Typical Site Conditions  
(Image facing south)*

**Segment 1.5 Alignment Options  
81st Avenue to 105th Avenue**

- Ⓐ BART ROW East
- Ⓑ BART ROW West
- Ⓒ UPRR ROW
- Ⓓ Public Street ROW- San Leandro Street Bike Lane

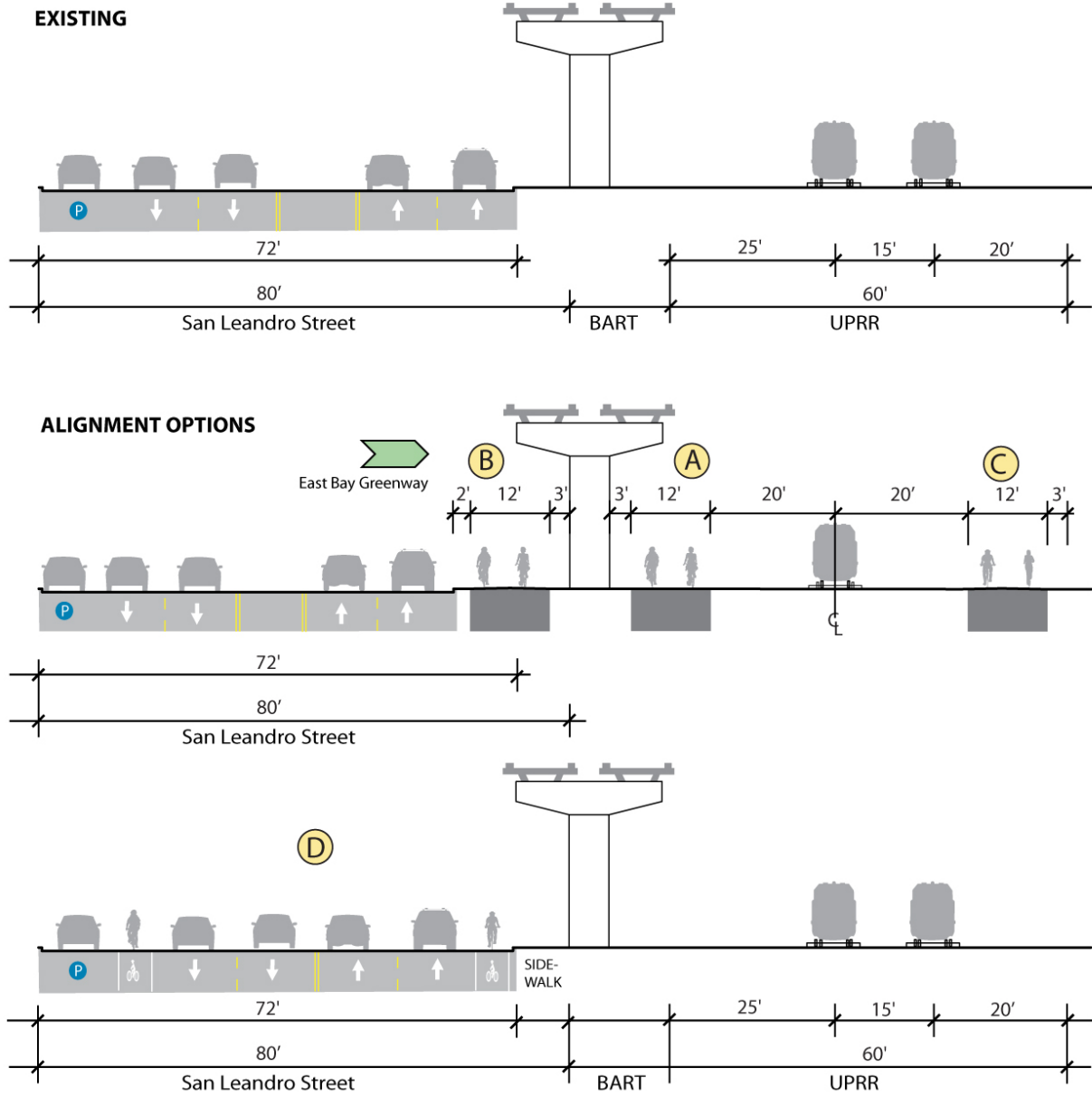

- Notes:
1. Property ownership/ROW varies significantly through the corridor and the sketch is a representation of typical dimensions.
  2. All dimensions presented are accurate for conceptual design and planning purposes only.
  3. All sections facing north.



*Figure 10: Segment 1.5 Alignment Options*

## Map 2: San Leandro

Map 2 begins at 105<sup>th</sup> Street in Oakland and continues to the San Leandro BART Station in San Leandro.

### *Segment 2.1: 105<sup>th</sup> Avenue to Peralta Avenue*

The corridor in Segment 2.1 includes elevated BART tracks, one at-grade UPRR track and runs parallel to San Leandro Street. At 105<sup>th</sup> Avenue San Leandro Street switches to the eastern side of the UPRR ROW and becomes San Leandro Boulevard. This segment is characterized by ample available right-of-way on both sides of the elevated BART structure and by parallel roadways on both sides of the shared rail right-of-way.

Segment 2.1 has four alignment options (**Figure 11**). Option A, a 12-foot multi-use path, would be possible with a 10-foot setback from existing rail. Narrow setbacks in this range only have precedent on existing RWT facilities where rail service is low-speed and low-frequency and where potential offset of peak trail use and freight service may be possible. Vertical separation such as fencing or walls would generally be required with such a narrow setback. Option C poses a similar scenario with only an 11-foot setback.

Option B is easily constructed and operated in the approximately 60 feet of undeveloped ROW west of the BART structure.

Another feasible alignment is a bike route on Russet Street (Option D). Russet Street parallels the corridor and may provide a short-term solution. An on-street alternative on San Leandro Boulevard is problematic due to the west to east roadway undercrossing.

The East Bay Greenway's preferred route is a multi-use path on the western edge of San Leandro Boulevard, adjacent to the UPRR ROW. The Oakland Bicycle Plan also includes a Class II bike lane on San Leandro Boulevard.



*Segment 2.1 Typical Site Conditions  
(Image facing south)*

**Segment 2.1 Alignment Options  
105th Avenue to Peralta Avenue**

- Ⓐ BART ROW East
- Ⓑ BART ROW West
- Ⓒ UPRR ROW- Infeasible unless rail removed
- Ⓓ Public Street ROW- Russell Street Bike Route

**EXISTING**

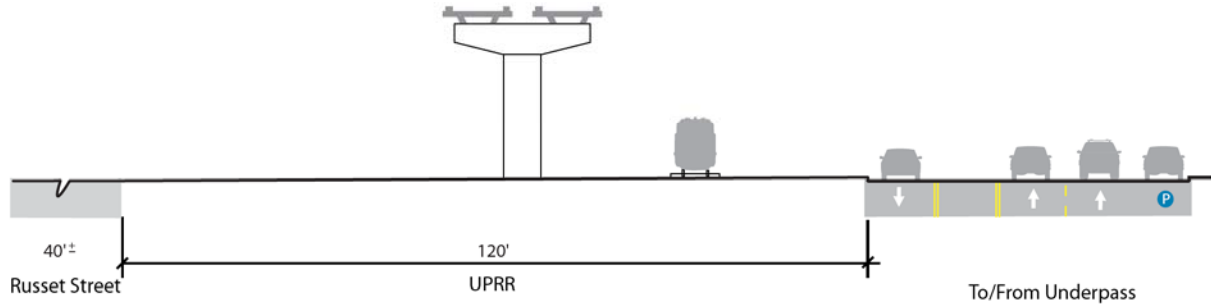

**ALIGNMENT OPTION**

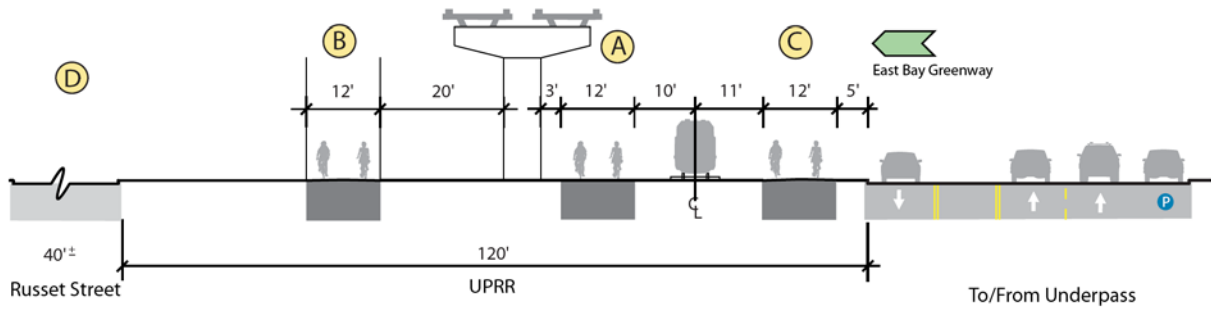

**Notes:**

1. Property ownership/ROW varies significantly through the corridor and the sketch is a representation of typical dimensions.
2. All dimensions presented are accurate for conceptual design and planning purposes only.
3. All sections facing north.



*Figure 11: Segment 2.1 Alignment Options*

### *Segment 2.2: Peralta Avenue to Marina Boulevard*

Segment 2.2 passes through Downtown San Leandro and includes the San Leandro BART Station. This segment parallels the elevated BART tracks and San Leandro Boulevard. There is one at-grade UPRR track and the ROW varies in width. There are no known potential rail scenarios that would affect this segment.

**Figure 12** and **Figure 13** show alignment options. The BART ROW East (Option A) would be infeasible because of existing freight tracks in the ROW.

Option B is a path within the BART ROW West. The ROW is varied but can accommodate a multi-use path.

Option C, is a 12-foot path within the UPRR ROW. This alignment provides for a 25-foot setback from the rail centerline and is within typical design standards for RWT.

Option D (**Figure 13**) includes an existing standard bike lane on San Leandro Street.

The East Bay Greenway's preferred route is the existing Class II bike lanes on San Leandro Boulevard.



*Segment 2.2 Typical Site Conditions  
(Image facing north)*



**Segment 2.2(A) Alignment Options  
Peralta Avenue to Marina Boulevard**

- Ⓐ BART ROW East- Infeasible without rail removal
- Ⓑ BART ROW West
- Ⓒ UPRR ROW
- Ⓓ Public Street ROW- Existing San Leandro Blvd. Bike Lane

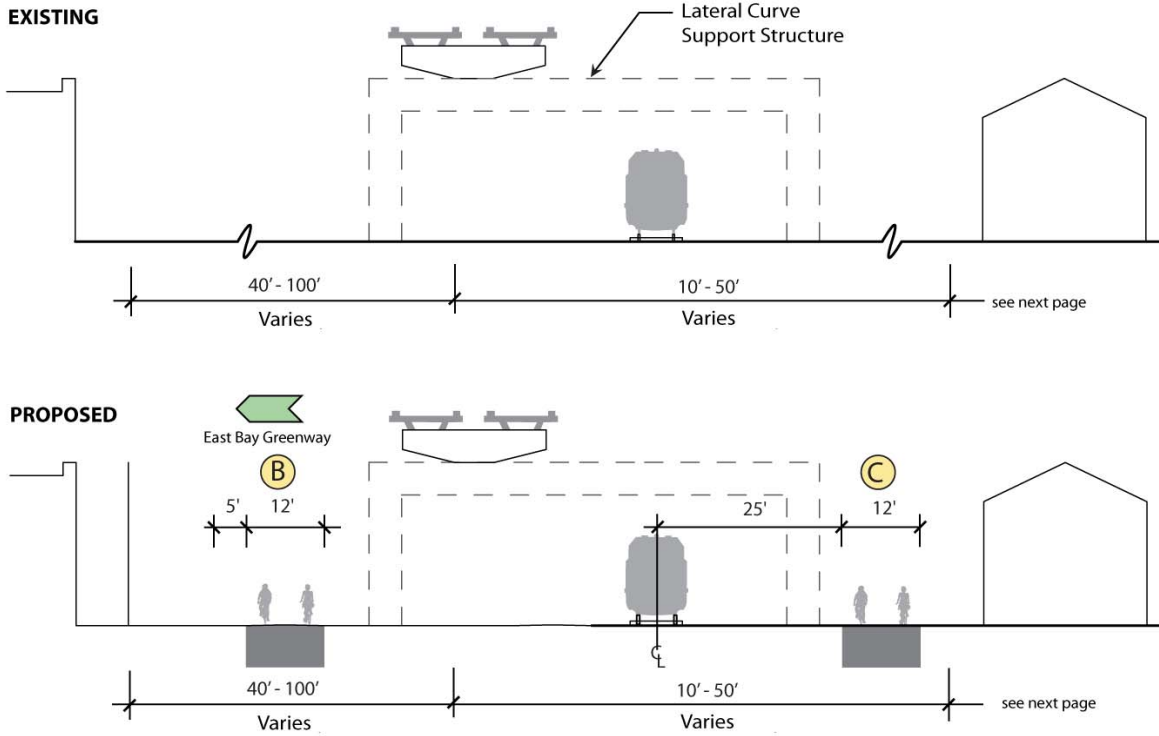

- Notes:
1. Property ownership/ROW varies significantly through the corridor and the sketch is a representation of typical dimensions.
  2. All dimensions presented are accurate for conceptual design and planning purposes only.
  3. All sections facing north.

*Figure 12: Segment 2.2A Alignment Options*

**Segment 2.2(B) Alignment Options  
Peralta Avenue to Marina Boulevard**

- Ⓐ BART ROW East
- Ⓑ BART ROW West
- Ⓒ UPRR ROW- Infeasible without rail removal
- Ⓓ Public Street ROW- Existing San Leandro Blvd. Bike Lane

**EXISTING**

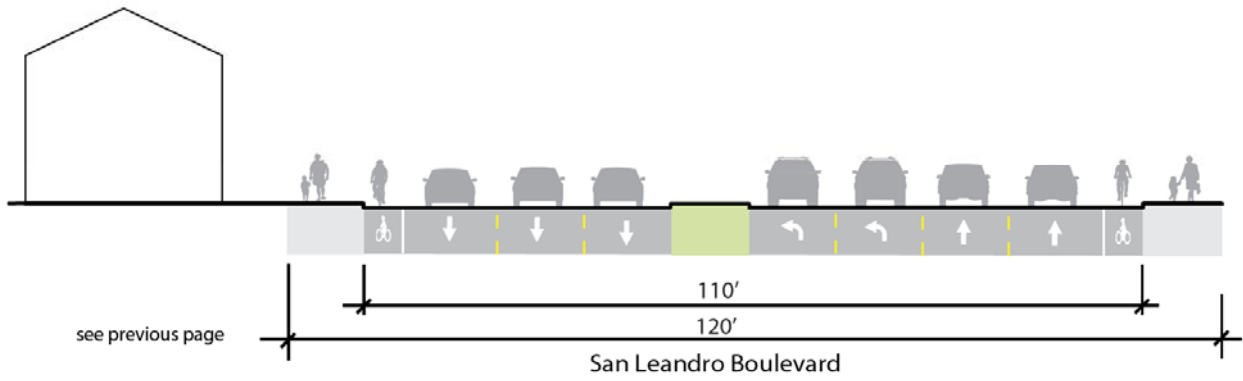

**ALIGNMENT OPTIONS**

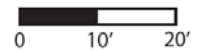
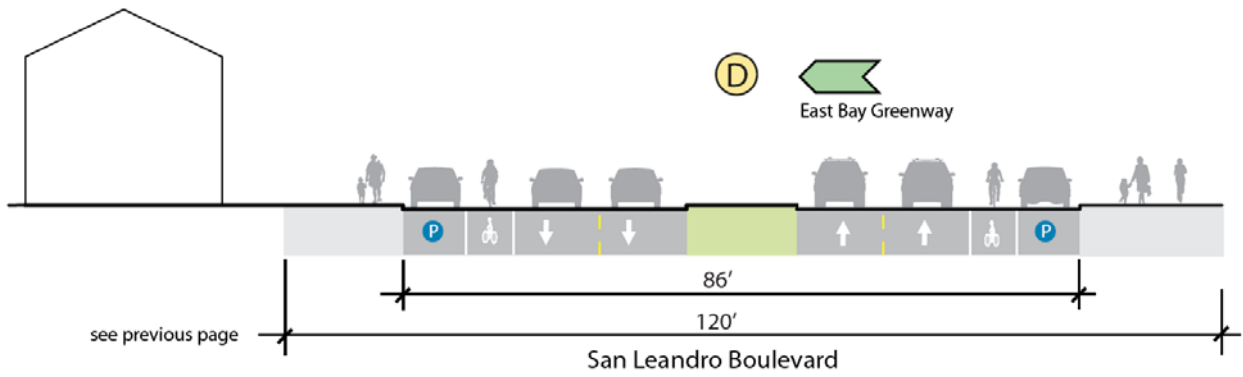

**Notes:**

1. Property ownership/ROW varies significantly through the corridor and the sketch is a representation of typical dimensions.
2. All dimensions presented are accurate for conceptual design and planning purposes only.
3. All sections facing north.

*Figure 13: Segment 2.2B Alignment Options*

*This page intentionally left blank*

### *Segment 2.3: Marina Boulevard to Hesperian Boulevard*

Segment 2.3 begins at Marina Boulevard at the southern boundary of Downtown San Leandro and continues south to Hesperian Boulevard. The ROW in this segment has elevated BART tracks, one at-grade freight track and potential alignment options on both the east and west sides of the shared ROW. San Leandro Boulevard is parallel to the corridor at the northern edge but turns east. Toward the southern end of the corridor, Western Avenue parallels the rail ROW to the west. There are no known potential future rail scenarios that would affect this segment.

**Figure 14** illustrates Segment 2.3 alignment options. Option A, a 12-foot path along the BART ROW East is feasible with a roadway configuration to include lane narrowing and an extension of the curb.

Option B, a 12-foot path within the BART ROW West, would be feasible with a 15-foot setback from the rail centerline. This setback is less than typical and may be acceptable with relatively low speed and frequency lines. Use of vertical separation or techniques such as fencing or walls would be required by rail operators allow for this narrow setback.

A 12-foot path within the UPRR ROW, Option C, is feasible on the western portion of the UPRR ROW with a 30-foot setback from the rail centerline. This setback is within the typical range of setback for RWTs.

Option D, a standard 5-foot bike lane on San Leandro Boulevard is possible with a lane width reduction. There is an existing bike lane on the north bound side of the street. The City of San Leandro would need to conduct a feasibility study to modify the roadway configuration to implement a south bound bike lane. The feasibility study would include review of available right-of-way and impacts to vehicular level of service.

The East Bay Greenway's preferred route is a multi-use path on the western edge of the UPRR ROW, similar to option C to 147<sup>th</sup> Street. South of 147<sup>th</sup> Street, the East Bay Greenway's preferred route is on the eastern edge of the BART ROW (Option A).



*Segment 2.3 Typical Site Conditions  
(Image facing south)*

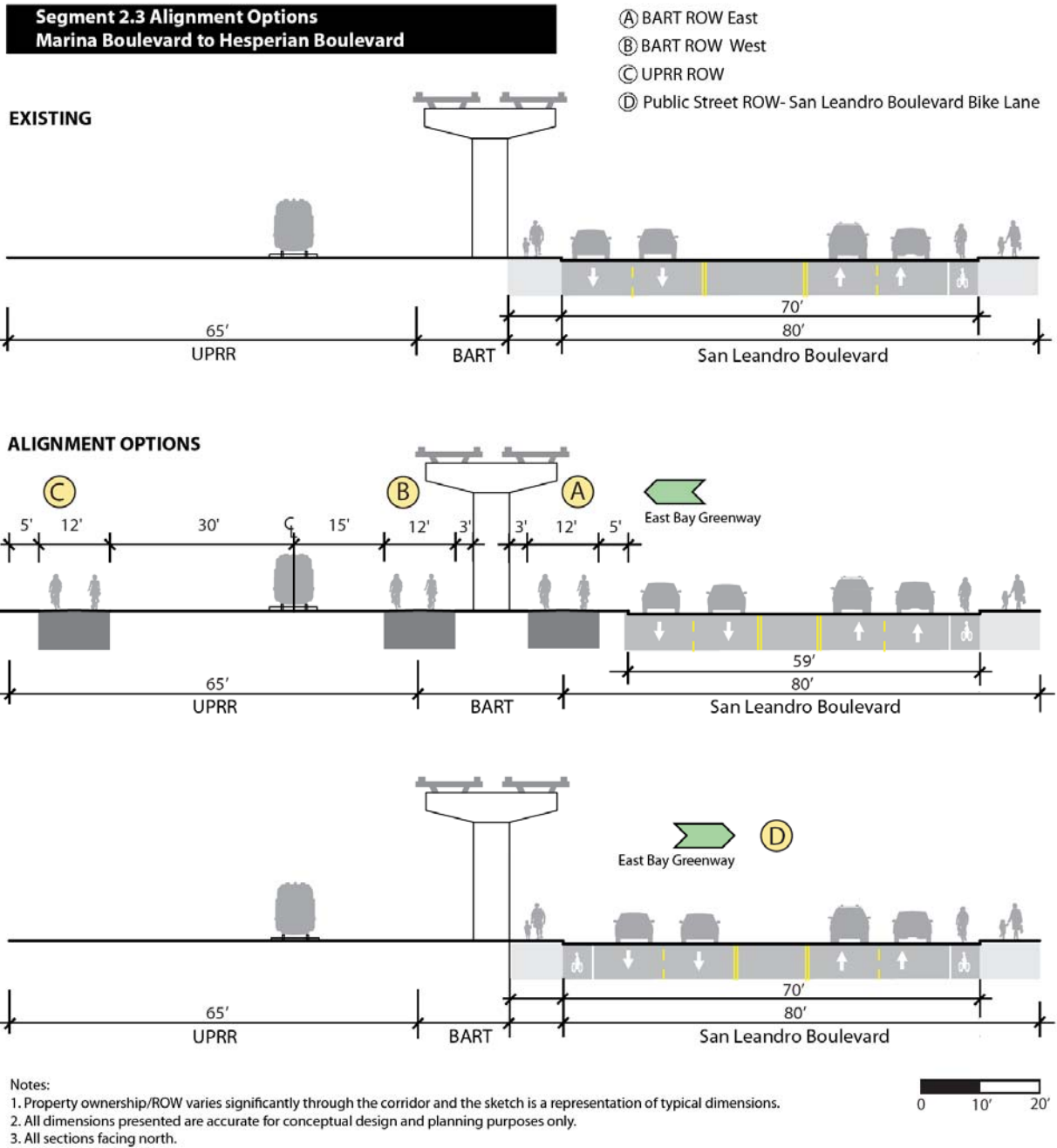

Figure 14: Segment 2.3 Alignment Options

## Map 3: Alameda County

Map 3 begins at the Bay Fair BART Station area of San Leandro and continues to the Hayward BART Station in Hayward. This map zone includes areas of San Leandro, Hayward and Unincorporated Alameda County.

### *Segment 3.1: Hesperian Boulevard to Elgin Way*

Segment 3.1 includes the Bay Fair BART Station, both elevated and at-grade BART tracks, a single UPRR rail line, and no parallel roadways. The ROW varies significantly in this segment from approximately 100 feet near the BART station to an estimated 200 feet in width toward the southern reaches of the segment. The potential third BART track near the Bay Fair BART station area is the only known potential rail scenario. At Bay Fair Station a third BART track under consideration by BART would limit potential multi-use pathway options, likely eliminating Option B from consideration. This third BART track would provide additional capacity for future service extensions to Warm Springs and Livermore. Bay Fair Station's role as a intra-regional transfer point will significantly increase with any future extension on the Richmond-Fremont Line or the Dublin-Pleasanton Line.

Alignment options north of the Bayfair BART Station are limited as illustrated in **Figure 15**. Option A, a path within the BART ROW East, is infeasible because of BART operations and available ROW. Option D, a facility on a parallel roadway is infeasible because there are no parallel roadways within reasonable distance for pedestrians and bicyclists.

Potential alignments include options B and C. A 12-foot path within the BART ROW West, Option B, is feasible with a 28-foot setback from the rail centerline. Option C, a 12-foot path within the UPRR ROW is possible with a 25-foot setback from the centerline. Both options include setbacks within typical standards.

The East Bay Greenway's preferred route is a multi-use path on the directly under of the BART ROW to the Bay Fair BART Station. After the station, the route is routed to a Class III bike route on Elgin Street.



*Segment 3.1 Typical Site Conditions  
(Image facing south)*

**Segment 3.1 A Alignment Options  
Hesperian Boulevard to Elgin Way  
North of Bay Fair Station**

- Ⓐ BART ROW East- Infeasible BART operations
- Ⓑ BART ROW West
- Ⓒ UPRR ROW
- Ⓓ Public Street ROW- Infeasible, no parallel roadway

**EXISTING**

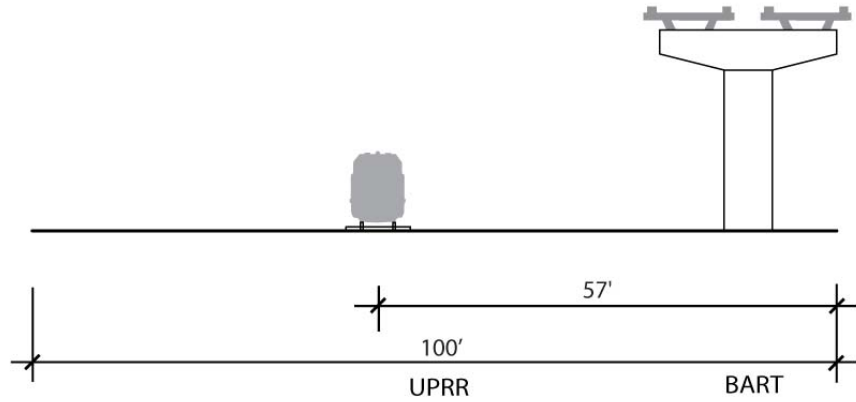

**PROPOSED**

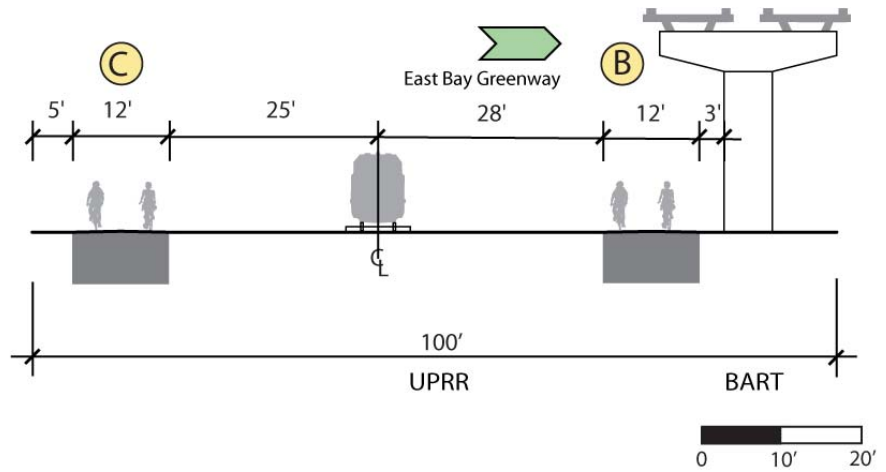

Notes:

1. Property ownership/ROW varies significantly through the corridor and the sketch is a representation of typical dimensions.
2. All dimensions presented are accurate for conceptual design and planning purposes only.
3. All sections facing north.

*Figure 15: Segment 3.1A Alignment Options*

**Figure 16** illustrates Segment 3.1 alignment options at the BART Station. There is no parallel roadway and, therefore, Option D is infeasible. Feasible options include A, B, and C.

Within the BART ROW, Options A, under the elevated tracks, a 12-foot path is feasible with the removal of some existing automobile parking. Option B, a 12-foot path within the BART ROW West is possible with an 18-foot setback from the rail centerline. This setback is less than typical and may be acceptable with relatively low speed and frequency lines. The use of vertical separation or techniques such as fencing or walls also may allow for this setback. Additionally, the UPRR ROW (Option C) provides ample room for a 12-foot multi-use path.

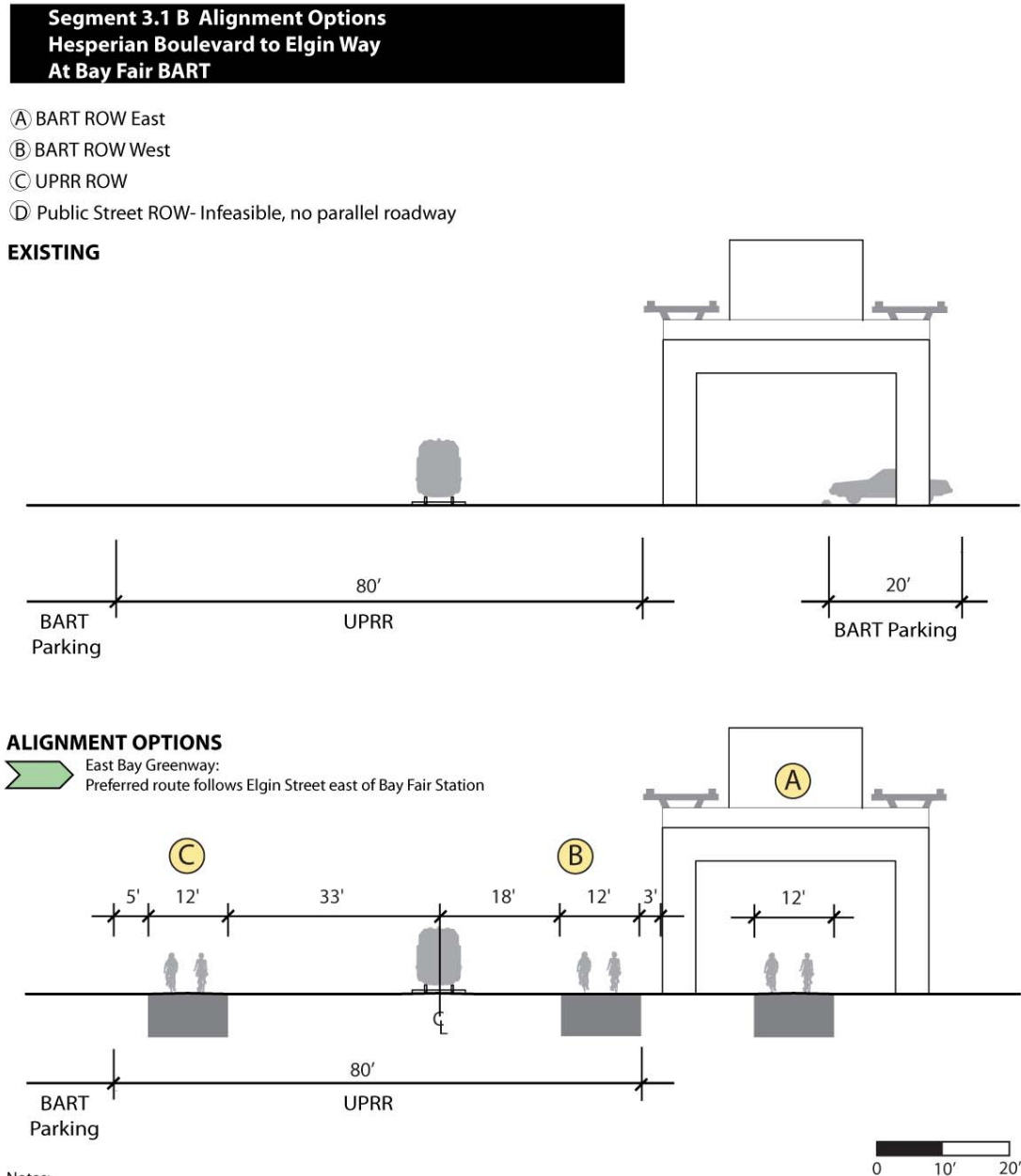

*Figure 16: Segment 3.1B Alignment Options*



*This page intentionally left blank*

### *Segment 3.2: Elgin Way to Hampton Road*

Segment 3.2 includes at-grade and elevated BART tracks, one at-grade UPRR track, an undercrossing under Interstate 238. The BART Dublin Pleasanton line branches from the Fremont line to the east requiring a grade separated track split. The ROW varies from approximately 70 to 100 feet. There are no known potential rail scenarios that would affect this segment.

Alignment options (Figure 17) are limited to the eastern portion of the UPRR ROW because of conflict with BART and the lack of parallel roadways. Option A, a path within the BART ROW East, is not feasible because of limited ROW, the Dublin Pleasanton track branch, and the Interstate 238 undercrossing. Option B, a path within the BART ROW West, would be infeasible because of proximity to the rail line. Finally, the lack of a parallel roadway eliminates Option D.

The only feasible alignment option in this segment is Option C. A 12-foot path with an approximately 33-foot setback can be accommodated on the western edge of the UPRR ROW. This setback is within typical design guidelines.

The East Bay Greenway's preferred route is a bicycle boulevard on Elgin Street connecting to another bicycle boulevard on Delano Street. A Class II bike lane on Ashland would connect users to another Class II on Lewelling Avenue. Lewelling Avenue would then connect to the BART ROW.



*Segment 3.2 Typical Site Conditions  
(Image facing south)*

**Segment 3.2 Alignment Options  
Elgin Way to Hampton Rd.**

- Ⓐ BART ROW East- Infeasible due to the I-238 undercrossings and the Dublin Pleasanton Line
- Ⓑ BART ROW West- Requires UPRR rail removal
- Ⓒ UPRR ROW
- Ⓓ No Parallel Street

**EXISTING**

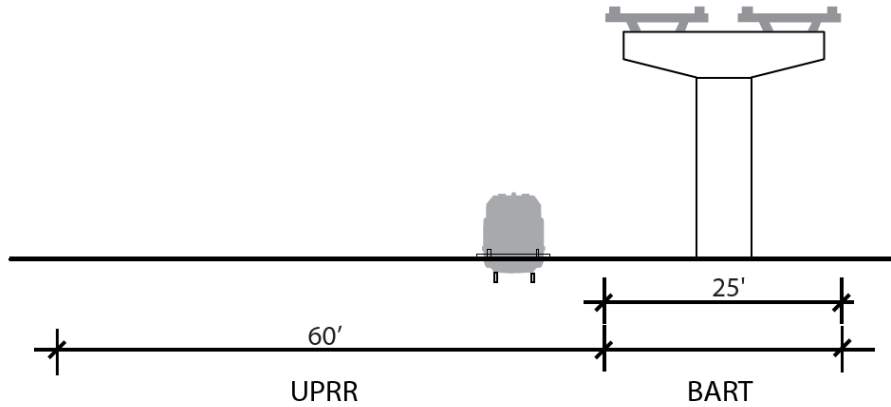

**ALIGNMENT OPTION**

 East Bay Greenway:  
Preferred route follows Elgin Street east of Bay Fair Station

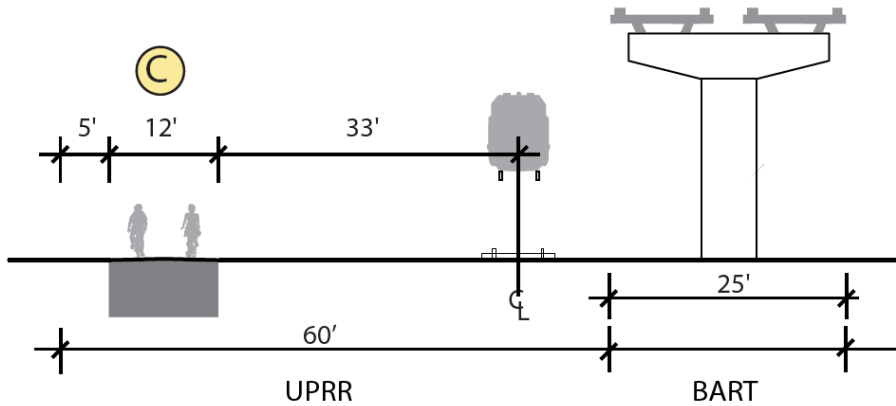

**Notes:**

1. Property ownership/ROW varies significantly through the corridor and the sketch is a representation of typical dimensions.
2. All dimensions presented are accurate for conceptual design and planning purposes only.
3. All sections facing north.

*Figure 17: Segment 3.2 Alignment Options*

### *Segment 3.3: Hampton Road to A Street*

Segment 3.3 includes elevated BART tracks and two parallel roadways. There are two UPRR at-grade tracks that have infrequent rail activity. The ROW is approximately 75 feet through the segment. There are no known potential rail scenarios that would affect this segment.

**Figure 18** shows Segment 3.3 alignment options. Options A and B, facilities within the BART ROW East or West are not feasible because of BART configuration. There is limited available ROW to the east and proximity to existing tracks limits options for alignments on the western edge.

Option C, a 12-foot multi-use path within the UPRR ROW is feasible dependent upon rail operation acceptance of an approximately 20-foot setback from the active freight rail centerline. This setback is less than typical and may be acceptable with relatively low speed and frequency lines and with use of barrier separation. With removal of the at-grade freight rail tracks there is ample space for Option C.

Option D, a facility within a public street ROW is possible. A bicycle boulevard on the low traffic volume Western Boulevard (western side) may be feasible depending on traffic volume, speeds, parking utilization and turnover. A detailed feasibility and design analysis would be required to determine the appropriateness of Western Boulevard as a bicycle boulevard.

The East Bay Greenway's preferred route is a bicycle boulevard on the western side of Western Boulevard.



*Segment 3.3 Typical Site Conditions  
(Image facing south)*

**Segment 3.3 Alignment Options  
Hampton Road to A Street**

- Ⓐ BART ROW East- Infeasible due to BART configuration
- Ⓑ BART ROW West - Requires UPRR Rail Removal
- Ⓒ UPRR ROW - 20' setback, unless rail removed
- Ⓓ Public Street ROW- Western Boulevard bike route

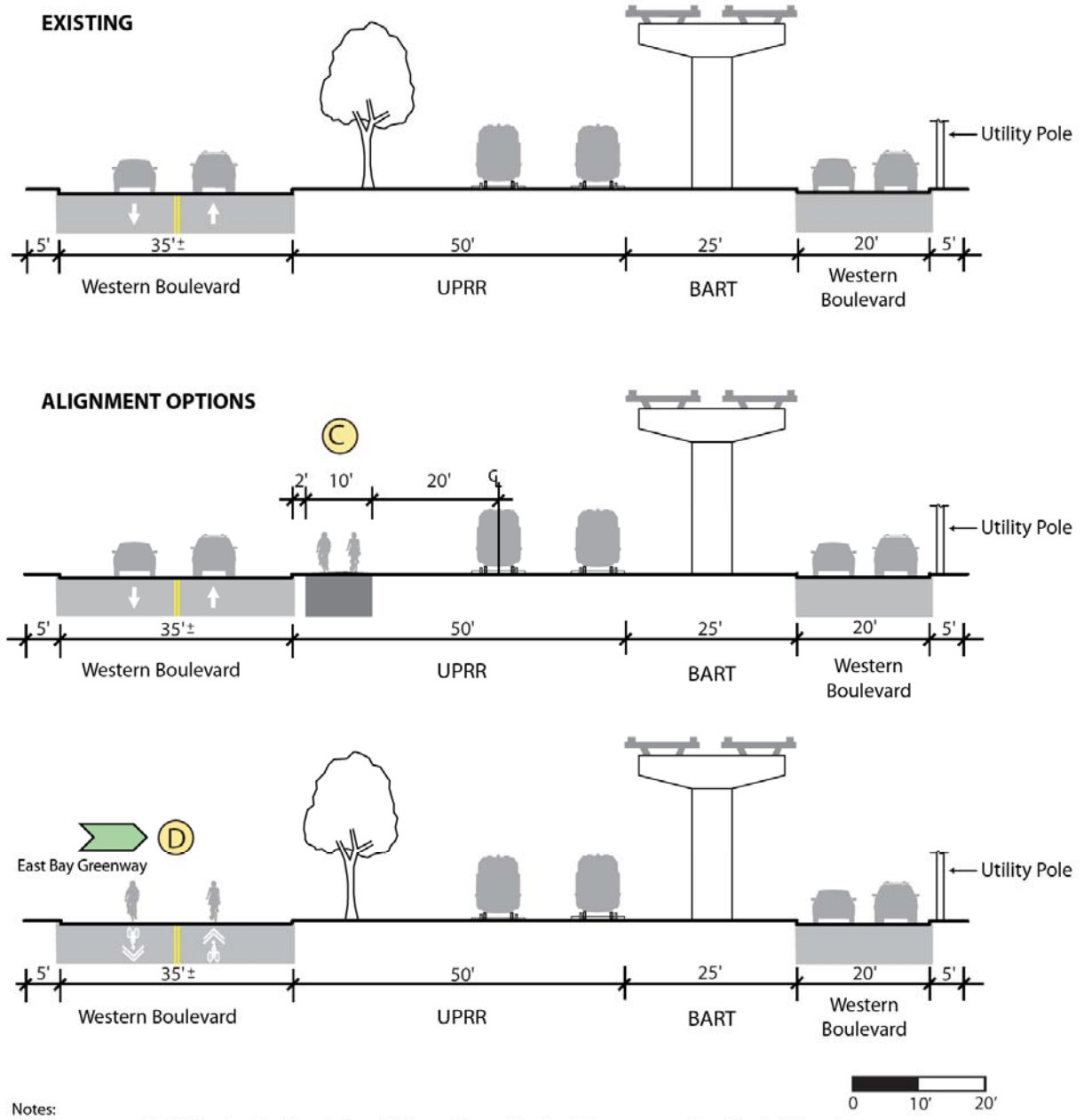

- Notes:
1. Property ownership/ROW varies significantly through the corridor and the sketch is a representation of typical dimensions.
  2. All dimensions presented are accurate for conceptual design and planning purposes only.
  3. All sections facing north.

Figure 18: Segment 3.3 Alignment Options

### *Segment 3.4: A Street to D Street*

Segment 3.4 is located in Downtown Hayward and includes the Hayward BART Station, at-grade BART tracks, two at-grade UPRR tracks, and has no parallel roadways. The corridor ROW is approximately 100 feet wide. There are no known potential rail scenarios that would affect this segment.

Alignment options (**Figure 19**) in this segment are limited to the western edge of the UPRR ROW. Options A and B, a path within the BART ROW, are infeasible because of BART configuration, utilities and drainage. Option D, a facility on a street within the public ROW is not feasible because there are no parallel roadways.

The only feasible alignment is Option C. Option C would be feasible with the removal, at minimum, of the western freight tracks. With both existing freight tracks in place, the setback from the existing rail centerline is 10-feet. This setback is less than typical and may be acceptable with relatively low speed and frequency lines and use of vertical separation as fencing or walls. With removal of freight rail there is ample space for Option C.

The East Bay Greenway's preferred route is a bicycle boulevard on Grand Street to B Street. A Class II bike lane on B Street will then direct users to the Hayward BART Station and the end of the East Bay Greenway.



*Segment 3.4 Typical Site Conditions  
(Image facing south)*

**Segment 3.4 Alignment Options  
A Street to D Street**

- Ⓐ BART ROW East- Infeasible due to BART configuration
- Ⓑ BART ROW West- Requires rail removal
- Ⓒ UPRR ROW- 10 foot setback, unless rail removed
- Ⓓ Public Street ROW- Infeasible, no parallel roadways

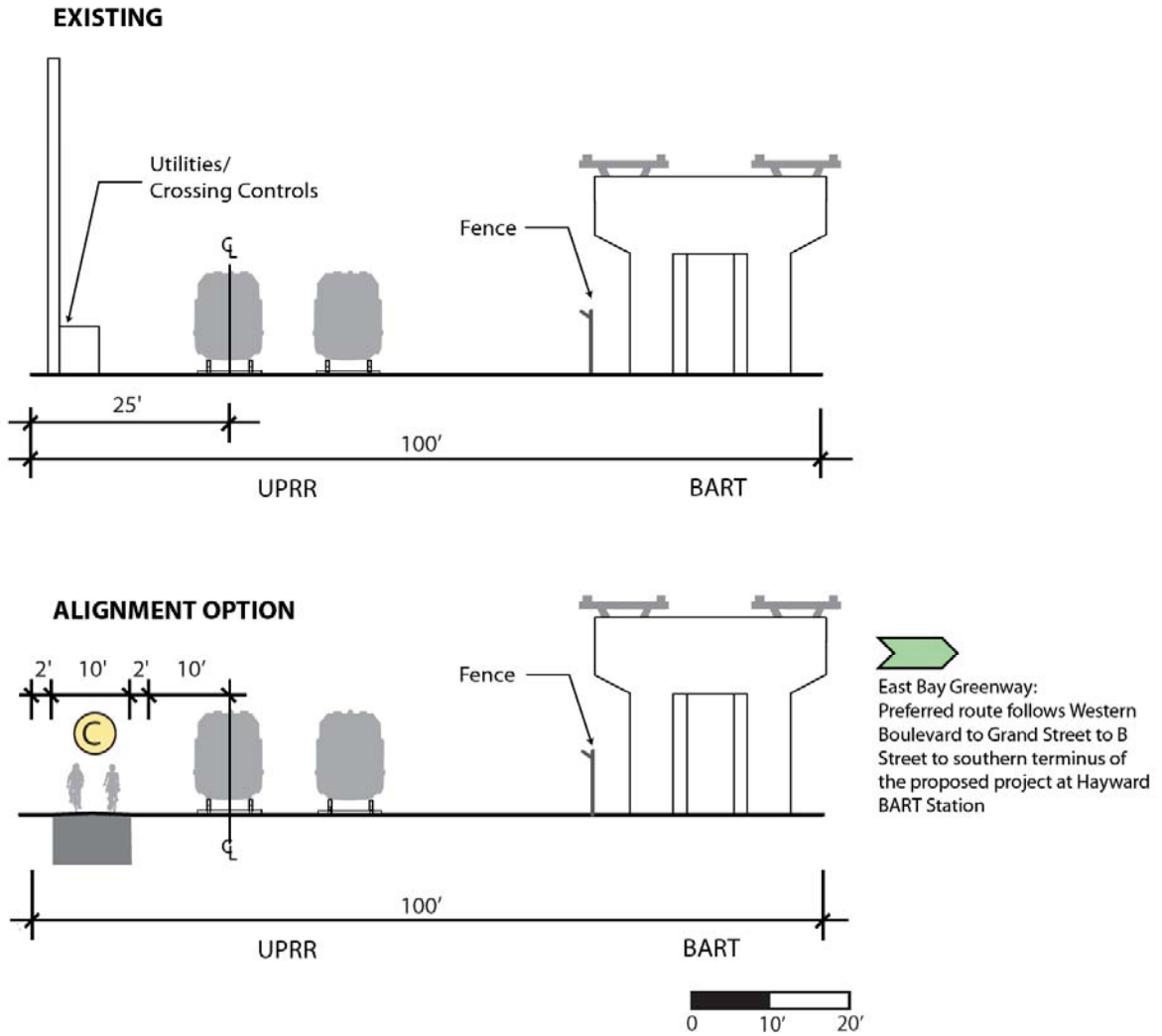

- Notes:
1. Property ownership/ROW varies significantly through the corridor and the sketch is a representation of typical dimensions.
  2. All dimensions presented are accurate for conceptual design and planning purposes only.
  3. All sections facing north.

*Figure 19: Segment 3.4 Alignment Options*

### *Segment 3.5: D Street to Sycamore Avenue*

Segment 3.5 is in Central Hayward and includes two at-grade BART tracks and two at-grade UPRR tracks. The ROW is approximately 100 feet and there are no parallel roadways. There are no known potential rail scenarios that would affect this segment.

Alignment options (**Figure 20**) are limited to a multi-use path on the western edge of the UPRR ROW. Options A and B, a path within the BART ROW, are infeasible due to BART configuration and available ROW. Option D, an on-street facility is not possible because of the lack of parallel roadways.

The only feasible alignment option is within the UPRR ROW (Option C). A 12-foot path on the western edge of the UPRR ROW with a 28-foot setback would be within typical design standards. Existing utility and drainage considerations would require more detailed analysis.



*Segment 3.5 Typical Site Conditions  
(Image facing south)*



**Segment 3.5 Alignment Options  
D Street to Sycamore Avenue**

- (A) BART ROW East- Infeasible due to BART configuration
- (B) BART ROW West- Infeasible due to BART configuration
- (C) UPRR ROW- 30' setback, unless rail removed
- (D) Public Street ROW- Infeasible, no parallel roadways

**EXISTING**

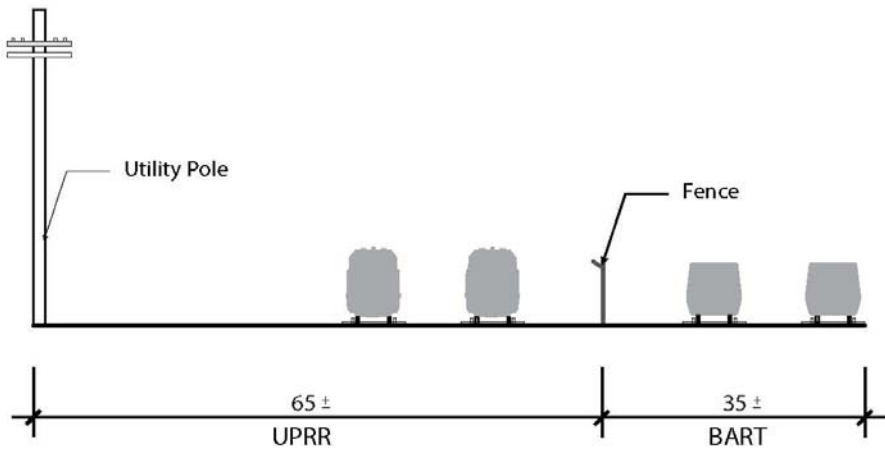

**ALIGNMENT OPTION**

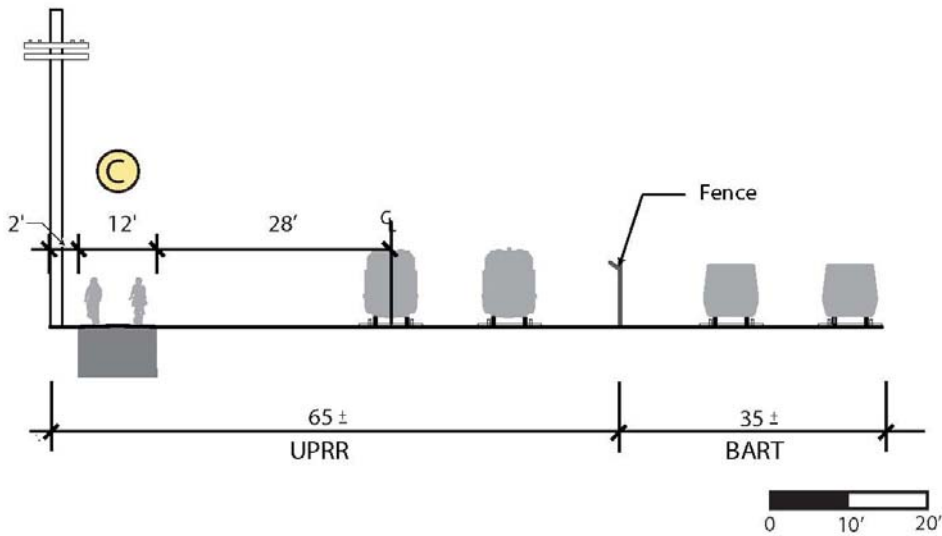

**Notes:**

1. Property ownership/ROW varies significantly through the corridor and the sketch is a representation of typical dimensions.
2. All dimensions presented are accurate for conceptual design and planning purposes only.
3. All sections facing north.

*Figure 20: Segment 3.5 Alignment Options*

### *Map 4: Hayward*

Map 4 begins in Central Hayward and continues south to Industrial Parkway where the Oakland Subdivision and Niles Subdivision cross at a grade-separated crossing.

#### *Segment 4.1: Sycamore Avenue to Sorensen Road*

Segment 4.1 includes two at-grade BART tracks and one at-grade UPRR track. The right of way is approximately 100 feet wide and parallels Whitman Street. There are no known potential rail scenarios that would affect this segment.

Alignment options (**Figure 21**) in this segment include facilities within the UPRR ROW and on Whitman Street. Options A and B, a path within the BART ROW, are infeasible because of BART configuration.

Possible alignments include Options C and D. Option C, a 10-foot path within the UPRR ROW is feasible with a 25-foot setback from the existing UPRR tracks. This setback is within typical design standards.

Option D presents standard 5-foot bike lanes or a Class I facility within the public street ROW. This alternative will require the removal of on-street parking on one side of the roadway. The City of Hayward would need to conduct a feasibility study in order to remove on-street parking. The feasibility study would include review of available right-of-way and impacts to vehicular level of service.



*Segment 4.1 Typical Site Conditions  
(Image facing south)*

**Segment 4.1 Alignment Options  
Sycamore Avenue to Sorensen Road**

- (A) BART ROW East - Infeasible due to BART configuration
- (B) BART ROW West - Infeasible
- (C) UPRR ROW - 25' setback, unless rail removed
- (D) Public Street ROW - Whitman Street bicycle lanes or road reconfiguration for Class I

**EXISTING**

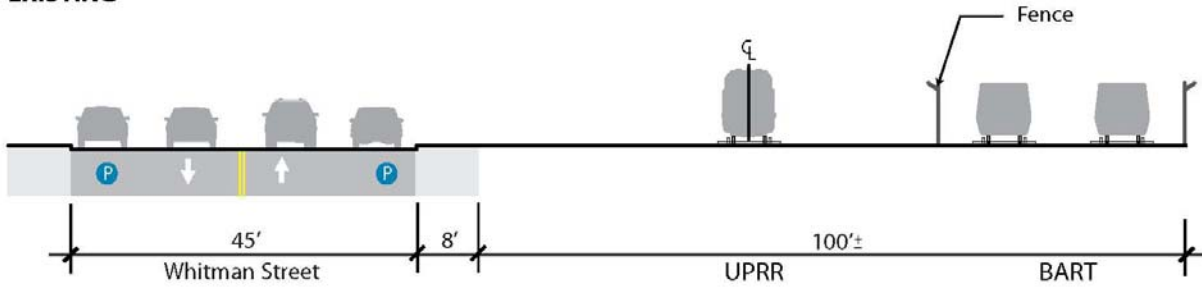

**ALIGNMENT OPTIONS**

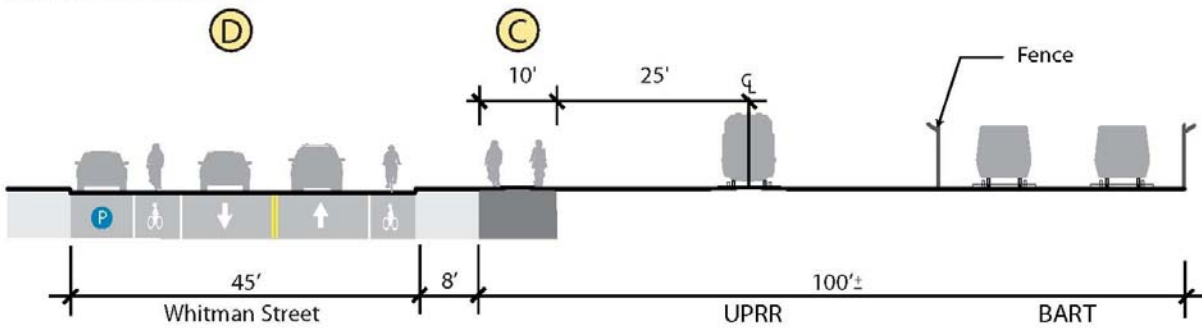

**Notes:**

1. Property ownership/ROW varies significantly through the corridor and the sketch is a representation of typical dimensions.
2. All dimensions presented are accurate for conceptual design and planning purposes only.
3. All sections facing north.



*Figure 21: Segment 4.1 Alignment Options*

### *Segment 4.2: Sorenson Road to Tennyson Road*

Segment 4.2 begins at Sorenson Road and continues south to Tennyson Road, passing through predominantly residential areas of Hayward. The segment has two at-grade BART tracks, one at-grade freight track, and a parallel City of Hayward path through a park. There are no known potential rail scenarios that would affect this segment.

Alignment options (**Figure 22**) are limited. Options A and B, paths within the BART ROW, are infeasible due to lack of available ROW. Option D, a facility on a public street is not feasible because there are no parallel roadways.

Option C, a multi-use path within the UPRR ROW and Option E, an existing path through Nuestro Parquito that parallels the corridor are feasible alignments. Alignment C, a 10-foot path with a 30-foot setback from the rail centerline is feasible on the western edge of the UPRR ROW. Option E would be a connection to the existing path through Neustro Parquito.



*Segment 4.2 Typical Site Conditions  
(Image facing south)*

**Segment 4.2 Alignment Options  
Sorensen Road to Tennyson Road**

- Ⓐ BART ROW East- Infeasible due to BART configuration
- Ⓑ BART ROW West- Infeasible due to BART configuration
- Ⓒ UPRR ROW- 35' setback, unless rail removed
- Ⓓ Public Street ROW- Infeasible, no parallel through/connecting roadways
- Ⓔ City ROW- Existing path

**EXISTING**

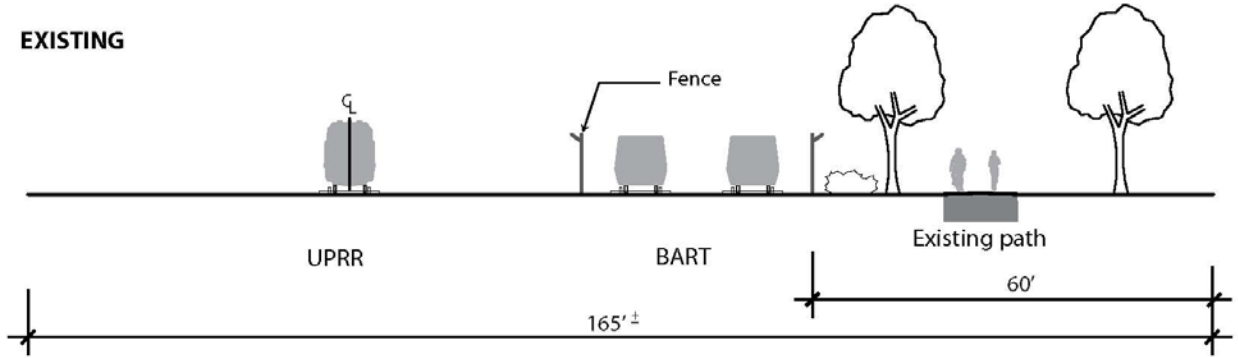

**ALIGNMENT OPTIONS**

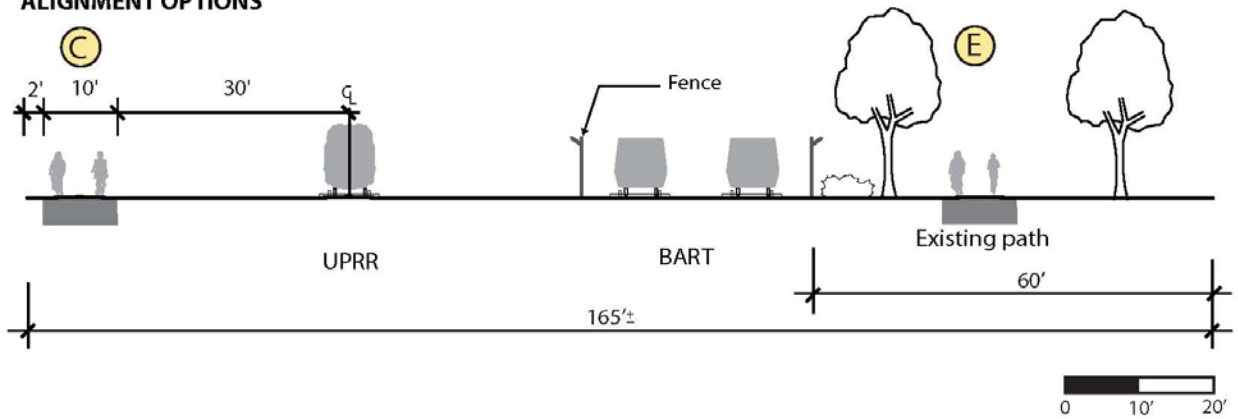

**Notes:**

1. Property ownership/ROW varies significantly through the corridor and the sketch is a representation of typical dimensions.
2. All dimensions presented are accurate for conceptual design and planning purposes only.
3. All sections facing north.

*Figure 22: Segment 4.2 Alignment Options*

### *Segment 4.3: Tennyson Road to Industrial Parkway*

Segment 4.3 begins at Tennyson Road and continues south to Industrial Parkway. It includes the South Hayward BART Station, two at-grade BART tracks, two at-grade UPRR tracks, and is approximately 100 feet wide. All rail tracks are located on a raised berm. There are no known potential rail scenarios that would affect this segment.

Alignment options (**Figure 23**) are limited to a multi-use path within the UPRR ROW. Options A and B, a path within the BART ROW, are not feasible because grade change and limited ROW. Alignment D, a facility on a public street, is not feasible because there are no parallel roadways.

A potentially feasible alignment is Option C, a 12-foot path located at the base of the existing berm. This alignment is dependent on property ownership, drainage conditions, and biological conditions. In addition, the Tennyson Road vicinity is constrained by the existing rail overcrossing configurations. Should this segment prove infeasible based on further analysis, a separate parallel alignment will be necessary.



*Segment 4.3 Typical Site Conditions  
(Image facing south)*

**Segment 4.3 Alignment Options  
Tennyson Road to Industrial Parkway**

- Ⓐ BART ROW East- No feasible alignment alternative
- Ⓑ BART ROW West- No feasible alignment alternative
- Ⓒ UPRR ROW- Located at base elevation of berm
- Ⓓ Public Street ROW- Infeasible, no parallel roadways

**EXISTING**

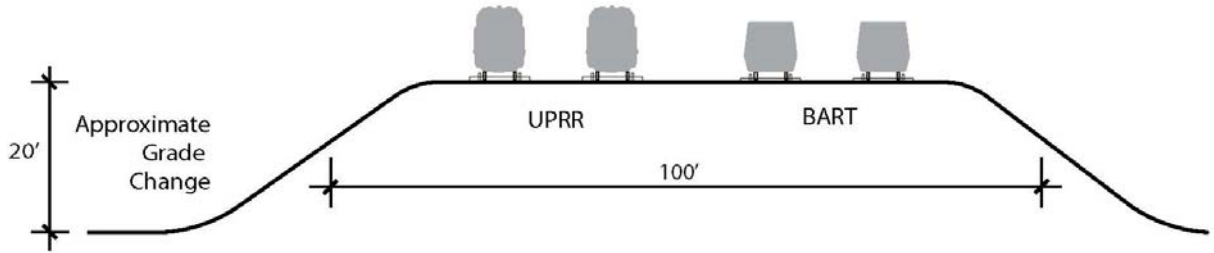

**ALIGNMENT OPTIONS**

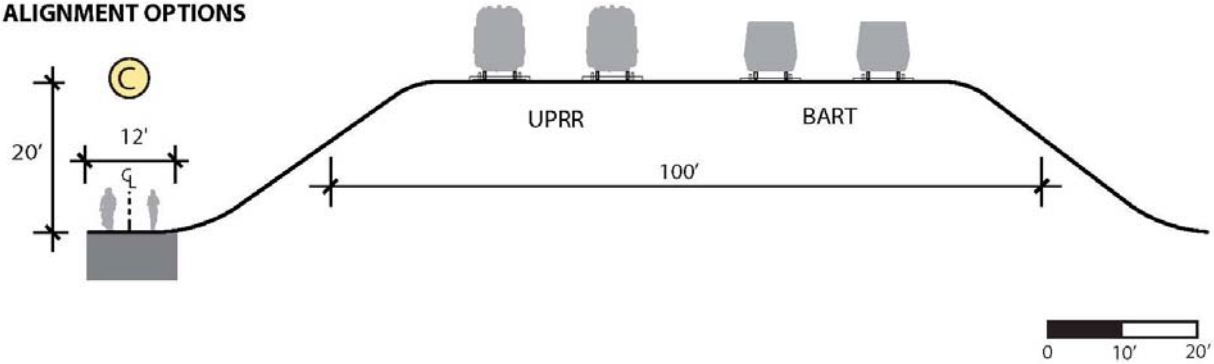

**Notes:**

1. Property ownership/ROW varies significantly through the corridor and the sketch is a representation of typical dimensions.
2. All dimensions presented are accurate for conceptual design and planning purposes only.
3. All sections facing north.

*Figure 23: Segment 4.3 Alignment Options*

### *Segment 4.4: Industrial Parkway to Whipple Road*

Segment 4.4 includes two at-grade UPRR tracks, the BART rail yard and a BART maintenance access road. The Niles Subdivision crosses over the Oakland Subdivision just south of the Industrial Parkway at the northern end of this segment. The UPRR corridor is not adjacent to the BART tracks. The UPRR ROW is approximately 100 feet wide. Potential rail scenarios that would affect this segment include Capitol Corridor Service south of Industrial Boulevard and short-haul freight.

**Figure 24** shows Segment 4.4 alignments. Alignment options are limited because of BART operations and planned Capitol Corridor operations and storage. Options A and B, a path within the BART ROW, are infeasible because of BART activities, safety and security considerations at the BART maintenance yard, and potential development of a third BART track. A path within the UPRR ROW (Option C) is infeasible because of planned Capitol Corridor operations and storage tracks. Option D is not feasible because the nearest parallel roadways are discontinuous.

The only feasible alignment is Option E. Option E is a proposed alternative alignment on the existing Mission Boulevard Greenway. This alignment will keep path users away from BART and Capitol Corridor activities, however, the Mission Boulevard Greenway is one-half mile to the east of the corridor. The east-west connections from the UPRR Oakland Subdivision alignment to Mission Boulevard are Industrial Parkway in the north and Whipple Road in the south.



*Segment 4.3 Typical Site Conditions  
(Image facing east)*



**Segment 4.4 Alignment Options  
Industrial Parkway to Whipple Road**

- Ⓐ BART ROW East- No feasible alignment alternative
- Ⓑ BART ROW West- No feasible alignment alternative
- Ⓒ UPRR ROW- Infeasible due to Capitol Corridor planned operations and storage tracks
- Ⓓ Public Street ROW- Infeasible, BART maintenance access road discontinuous
- Ⓔ Mission Boulevard Greenway

**EXISTING**

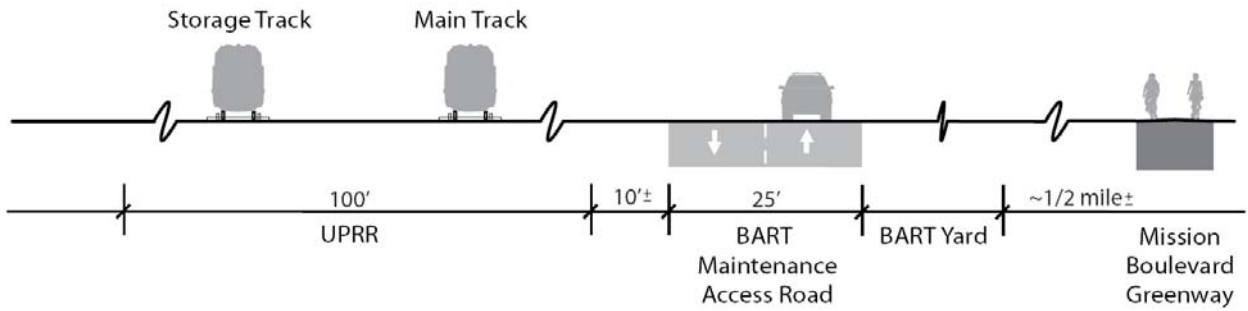

**ALIGNMENT OPTIONS**

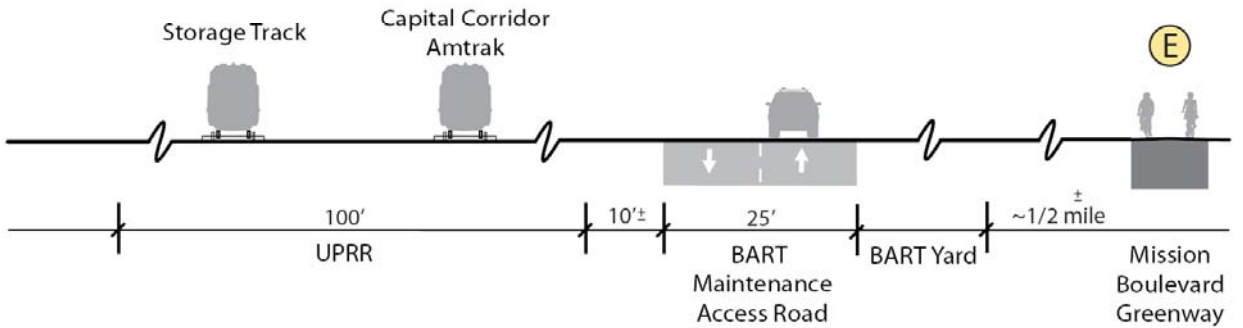

Figure 24: Segment 4.4 Alignment Options

## Map 5: Union City

Map 5 begins at Whipple Road and continues south to the Union City BART Station. Planned and anticipated rail use for this map area of the Oakland Subdivision includes Capitol Corridor/Amtrak, Dumbarton Rail, and UPRR freight.

### *Segment 5.1: Whipple Road to Westgard Street*

Segment 5.1 includes two at-grade UPRR rail tracks and is approximately 100 feet wide. This segment is not adjacent to BART tracks and has no immediate parallel roadways. Potential rail scenarios that would affect this segment include Capitol Corridor Service on the Oakland Subdivision and short-haul freight service.

Alignment options (**Figure 25**) in this segment are limited to a path within the UPRR ROW. Options A and B, a path within the BART ROW, are not feasible because the ROW is not adjacent to the corridor and is located east of the BART maintenance yard. Obstructions described in the previous segment restrict access to the BART ROW. Additionally, there are no parallel roadways (Option D) providing for an on-street facility.

Option C, a 10-foot path within the UPRR ROW, is feasible on the eastern edge of the corridor with a 25-foot setback from the planned Capitol Corridor track. Because Capitol Corridor activity is likely to be more frequent and at higher speeds than freight, a fence would be required to separate the track from the trail, per rail-with-trail engineering best practices.



*Segment 5.1 Typical Site Conditions  
(Image facing south)*

**Segment 5.1 Alignment Options  
Whipple Road to Westgard Street**

- (A) BART ROW East- No feasible alignment alternative
- (B) BART ROW West- No feasible alignment alternative
- (C) UPRR ROW- 25' setback from Capitol Corridor
- (D) Public Street ROW- Infeasible, no parallel roadways

**EXISTING**

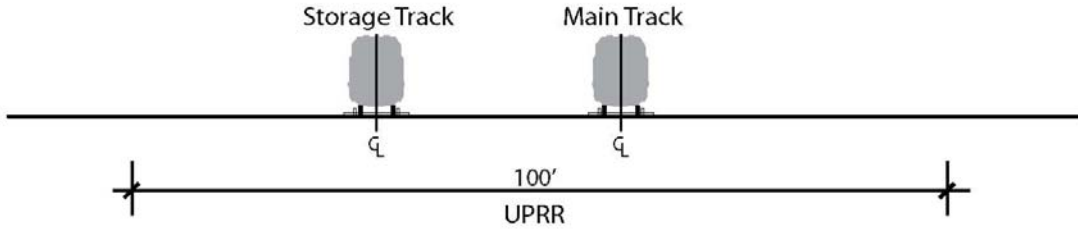

**ALIGNMENT OPTIONS**

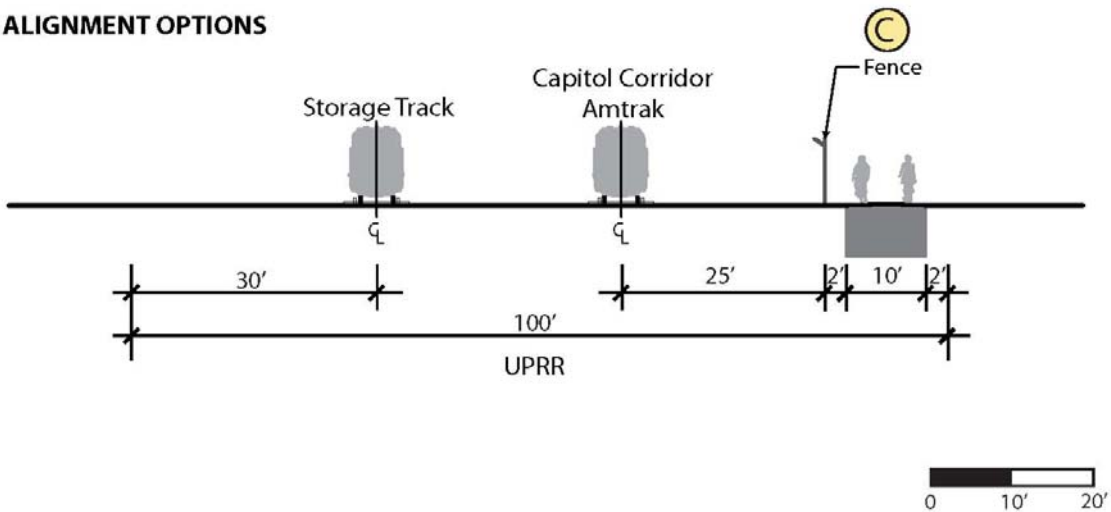

**Notes:**

1. Property ownership/ROW varies significantly through the corridor and the sketch is a representation of typical dimensions.
2. All dimensions presented are accurate for conceptual design and planning purposes only.
3. All sections facing north.

*Figure 25: Segment 5.1 Alignment Options*

### *Segment 5.2: Westgard Street to Decoto Road*

Segment 5.2 begins at Westgard Road in the industrial area north of central Union City and continues south to Decoto Road, the northern boundary of the Union City Intermodal Station area. This segment has one at-grade UPRR rail line, elevated BART tracks, and is approximately 100 feet wide. 11<sup>th</sup> Street and 12<sup>th</sup> Street parallel the railroad ROW. Potential rail scenarios that would affect this segment include Capitol Corridor Service on the Oakland Subdivision and short-haul freight service.

**Figure 26** shows Segment 5.2 alignment options. Option B, a path within the BART ROW West, is infeasible because limited = ROW.

Feasible alignment options include Options A, C and D. Option A, a 10 foot path within the BART ROW East is feasible though it meets only minimum pathway standards. To the west, a 12-foot path within the UPRR ROW (Option C) is also feasible. This option would have a 40-foot setback from the rail centerline.

Finally, an on-street facility, Option D, is possible on 12<sup>th</sup> Street or 11<sup>th</sup> Street per City of Union City bicycle plans. 12<sup>th</sup> Street can be reconfigured to become a bicycle boulevard. Potential configurations include the removal on the eastern curbside parking and the installation of a sidewalk. The City of Union City would need to conduct a feasibility study in order to remove on-street parking. The feasibility study would include review impacts to vehicular level of service.



*Segment 5.2 Typical Site Conditions  
(Image facing south)*

**Segment 5.2 Alignment Options  
Westgard Street to Decoto Road**

- Ⓐ BART ROW East
- Ⓑ BART ROW West
- Ⓒ UPRR ROW- 25' setback from Capitol Corridor
- Ⓓ Public Street ROW- 12th Street sidewalk and Bicycle Boulevard

**EXISTING**

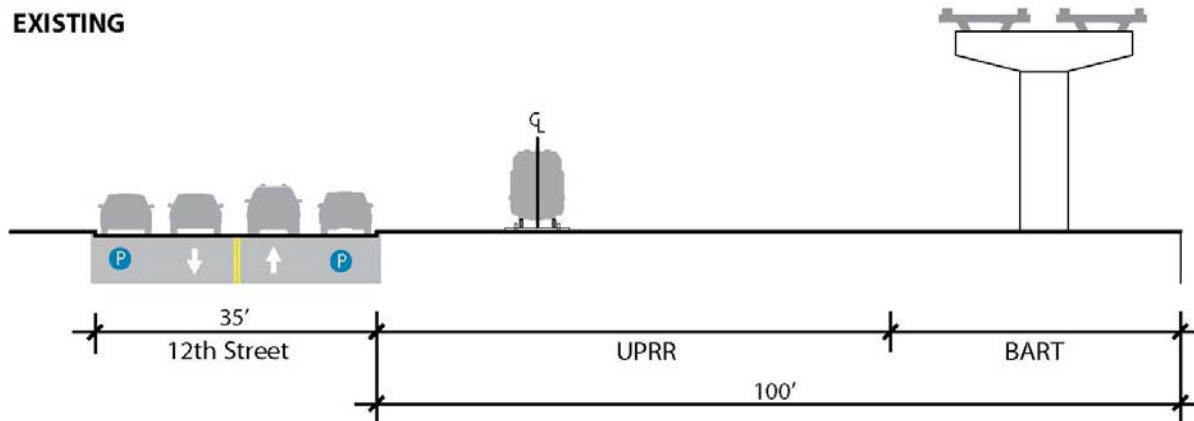

**ALIGNMENT OPTIONS**

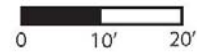
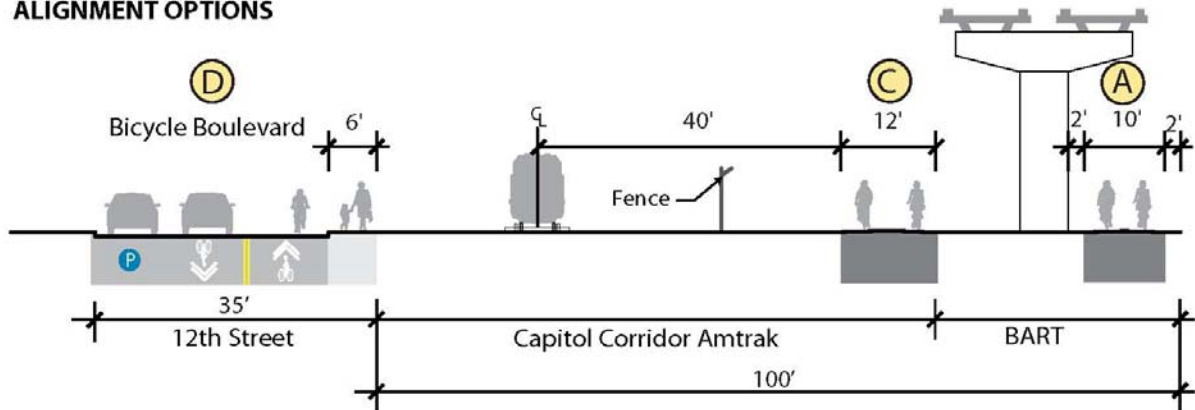

**Notes:**

1. Property ownership/ROW varies significantly through the corridor and the sketch is a representation of typical dimensions.
2. All dimensions presented are accurate for conceptual design and planning purposes only.
3. All sections facing north.

*Figure 26: Segment 5.2 Alignment Options*

### *Segment 5.3: Decoto Road to Alvarado Niles Road*

Segment 5.3 includes two at-grade BART lines, one at-grade UPRR track, and the Union City BART Station. The UPRR ROW is approximately 100 feet wide. Potential rail scenarios that would affect this segment include Capitol Corridor Service on the Oakland Subdivision, active short-haul freight, and a potential third BART track.

Alignment options (**Figure 27**) are limited because of BART and planned Capitol Corridor operations. Options A and B, a path within the BART ROW, are not feasible because of the Union City Intermodal Station that will serve both BART and Capitol Corridor/Amtrak. A path within the UPRR ROW (Option C) is also not feasible because of planned track changes and Capitol Corridor service in the UPRR ROW.

Option D, a path on a public street, is the only feasible option for this segment. Existing Class II bike lanes on 11<sup>th</sup> Street provide for bicyclist connectivity to the Union City Intermodal Station. The City of Union City recently updated its Bicycle and Pedestrian Master Plan documenting this option as the planned route through the Intermodal Station District.

A connection south to Quarry Lakes Regional Park, the Alameda Creek Regional Trail and potential future City of Fremont UPRR RWT facility is currently under consideration by the City of Union City. Union City is actively promoting inclusion of a Class I multi-use pathway in the State Route 84 Connector project that would achieve pedestrian and bicycle connectivity between the Intermodal Station and Alameda Creek Regional Trail at the City of Union City and City of Fremont boundary.



*Segment 5.3 Typical Site Conditions, 11<sup>th</sup> Street  
(Image facing south)*

**Segment 5.3 Alignment Options  
Decoto Road to Alvarado Niles Road**

- (A) BART ROW East- No feasible alignment alternative
- (B) BART ROW West- No feasible alignment alternative
- (C) UPRR ROW- No feasible alignment alternative
- (D) Public Street ROW- Existing 11th Street bicycle lanes

**EXISTING**

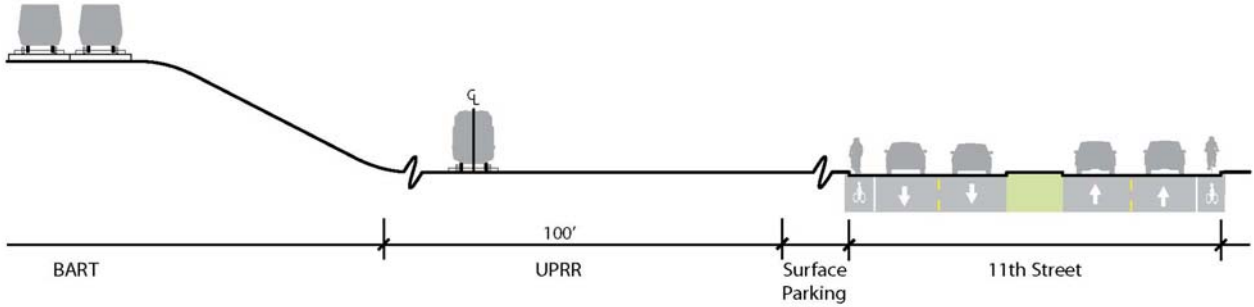

**ALIGNMENT OPTIONS**

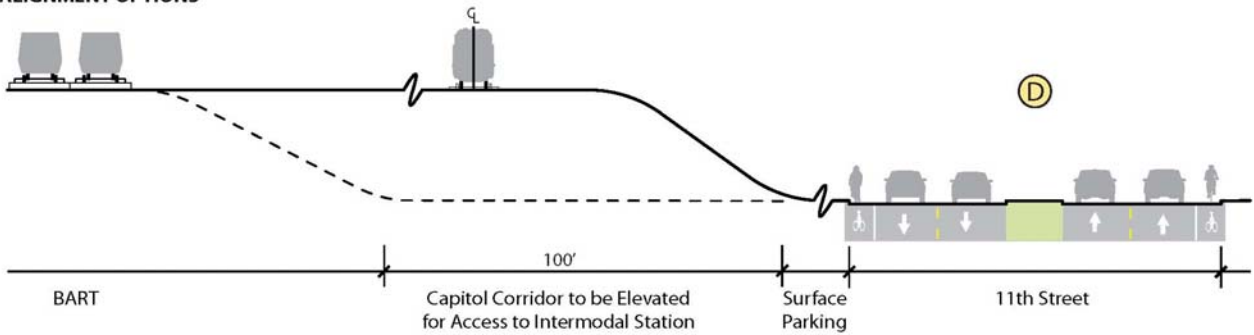

- Notes:
1. Property ownership/ROW varies significantly through the corridor and the sketch is a representation of typical dimensions.
  2. All dimensions presented are accurate for conceptual design and planning purposes only.
  3. All sections facing north.



*Figure 27: Segment 5.3 Alignment Options*

*This page intentionally left blank*



## Appendix A: HDR Memorandum

*This page intentionally left blank*



## MEMORANDUM

SUBJECT: CONCEPTUAL BART 3 <sup>RD</sup> TRACK	DATE: 5/22/09
TO: IAN MOORE, ALTA PLANNING & DESIGN	FROM: CHAEL BERITZHOFF, PROJECT MANAGER

The Union Pacific Oakland Subdivision Right-of-Way (ROW) generally lies adjacent to, and abuts the BART Right-of-Way between 47<sup>th</sup> Avenue in Oakland and the crossing of Alameda Creek in Fremont. The UP ROW varies in width, but averages approximately 100' wide. At several locations, for example in San Leandro, BART occupies UP property under a joint-use easement. UP has also granted BART extensive Temporary Construction Access (TCA) along the ROW for the BART Earthquake Safety Program.

HDR has prepared several representative layouts for a potential third BART track. These plans are based upon actual BART ROW layouts. These are all elevated structures. The UP ROW moves from one side of the BART ROW to the other several times and the actual location of UP railroad tracks varies considerably in relationship to the BART structures from location to location. These layouts reflect areas where the tracks are relatively close to the BART structures, and areas where there is considerably more room between them.

Along the BART ROW and the adjacent UP ROW there are many impediments to construction of a third BART track. These include housing, streets, businesses and utilities. However, along most of the line, the UP ROW provides the most feasible area for development of a third BART track.

As can be seen in the layouts, it is our opinion that it would be difficult, if not impossible, to accommodate a third BART elevated track, preserve an active railroad line and accommodate bike trails or other public uses with required UP and CPUC set-backs and clearances within the existing UPRR ROW.

There are at least two locations along the route that have grade separated UP/BART crossings; near Antonio Street in San Leandro and at I Street in Fremont, which would require complete removal of UP tracks from the ROW to accommodate any alternative uses. There may be other locations where physical restrictions would also require removal of tracks for the existing ROW to accommodate other than railroad uses.

UPRR CORRIDOR IMPROVEMENT STUDY  
PROJECT ALTERNATIVES MEMORANDUM

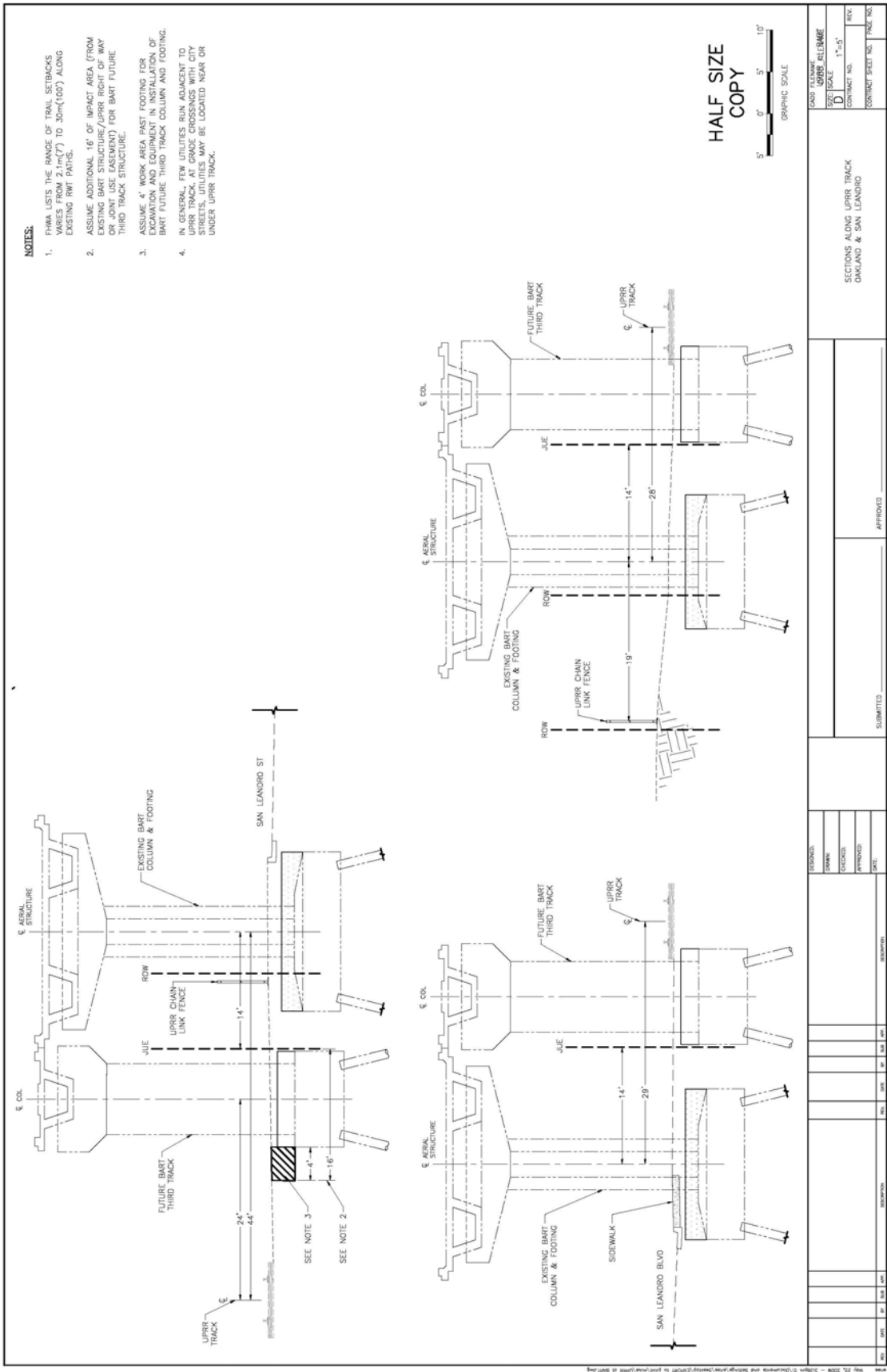

**NOTES:**

1. FWH ALLEYS THE RANGE OF TRAIL SETBACKS VARIES FROM 2.1m(6'7") TO 30m(100') ALONG EXISTING RWT PATHS.
2. ASSUME ADDITIONAL 16" OF IMPACT AREA (FROM EXISTING BART STRUCTURE/UPRR RIGHT OF WAY) IS REQUIRED FOR BART FUTURE THIRD TRACK STRUCTURE.
3. ASSUME 4' WORK AREA PAST FOOTING FOR EXCAVATION AND EQUIPMENT IN INSTALLATION OF BART FUTURE THIRD TRACK COLUMN AND FOOTING. IN GENERAL, FEW UTILITIES RUN ADJACENT TO UPRR TRACK. AT GRADE CROSSINGS WITH CITY UTILITIES, THE UTILITIES MAY BE LOCATED NEAR OR UNDER UPRR TRACK.

HALF SIZE  
COPY

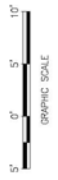

LOAD FILENAME: UPRR RELEASE		SECTION: UPRR RELEASE	
DRAWN: D		SCALE: 1"=50'	
CHECKED:		DATE:	
APPROVED:		DATE:	
SUBMITTED:		APPROVED:	

SECTIONS ALONG UPRR TRACK OAKLAND & SAN LEANDRO	
DATE	DRAWN
DATE	CHECKED
DATE	APPROVED
DATE	SUBMITTED
DATE	APPROVED